

## Effects of Mo Addition on the Microstructure and Mechanical Properties of Cast Microalloyed Steel

H. Torkamani<sup>1\*</sup>, H. Rashvand<sup>1</sup>, Sh. Raygan<sup>1</sup>, J. Rassizadehghani<sup>1</sup>, Y. Palizdar<sup>2</sup>, C. Garcia Mateo<sup>3</sup> and D. San Martin<sup>3</sup>

\* H.torkamani@ut.ac.ir

Received: March 2017

Accepted: August 2017

<sup>1</sup> School of Metallurgy and Materials Engineering, College of Engineering, University of Tehran, Tehran, Iran.

<sup>2</sup> Materials and Energy Research Center, Karaj, Iran.

<sup>3</sup> National Center for Metallurgical Research (CENIM-CSIC), Avda Gregorio delAmo, 8; Madrid, Spain.

DOI: 10.22068/ijmse.14.3.76

**Abstract:** In industry, the cost of production is an important factor and it is preferred to use conventional and low cost procedures for producing the parts. Heat treatment cycles and alloying additions are the key factors affecting the microstructure and mechanical properties of the cast steels. In this study an attempt was made to evaluate the influence of minor Mo addition on the microstructure and mechanical properties of conventionally heat treated cast microalloyed steels. The results of Jominy and dilatometry tests and also microstructural examinations revealed that Mo could effectively increase the hardenability of the investigated steel and change the microstructure features of the air-cooled samples. Acicular microstructure was the consequence of increasing the hardenability in Mo-added steel. Besides, it was found that Mo could greatly affect the isothermal bainitic transformation and higher fraction of martensite after cooling (from isothermal temperature) was due to the Mo addition. The results of impact test indicated that the microstructure obtained in air-cooled Mo-added steel led to better impact toughness (28J) in comparison with the base steel (23J). Moreover, Mo-added steel possessed higher hardness (291HV), yield (524MPa) and tensile (1108MPa) strengths compared to the base one.

**Keywords:** Mo Addition, Conventional Heat Treatment, Cast Microalloyed Steel, Mechanical Properties.

### 1. INTRODUCTION

Demands for producing low-cost high strength cast steels with acceptable toughness and weldability have encouraged researchers to focus on the cast grades of microalloyed steels [1-4]. Microstructure of low carbon cast micro-alloyed steels, generally, consists of ferrite and pearlite leading to poor mechanical properties compared to wrought grades while bainitic microstructure has positive effects on the final properties of these steels [5-8].

Alloying addition is one of the most important factors affecting the mechanical properties of cast steels which would diminish cast steels deficits in contrast to the wrought grades [7, 9, 10]. Among the alloying elements, Mo is well known for increasing the hardenability and reducing the critical cooling rate of steels which in low carbon steels leads to formation of phases other than ferrite and pearlite [11-15]. It has also been found that Mo decreases the Bs and Ms points.

Therefore, finer microstructure components would form at lower temperature [12, 16].

In addition, dispersion of fine precipitates, typically carbides/nitrides of the micro-alloying elements could further increase the strength of these steels [5, 9, 17]. In this regard, it has been reported that interaction of Mo with the micro-alloying elements results in improvement of precipitation [7, 13, 18, 19]. Hara et al. [20] have studied the effect of reduced carbon activity by Mo addition as a consequence of Mo-C cluster formation. Tanaka et al. [21] asserted that the diffusion rate of C in austenite would be decreased by Mo addition. These effects of Mo make carbon less available for micro-alloying precipitates resulting in finer precipitates with higher population density.

Fadel et al. [22] suggested that the addition or enrichment of Mn and Mo suppresses the formation of grain boundary ferrite, pearlite and acicular ferrite and promotes the formation of bainite in a medium carbon microalloyed steel.

Sourmail and Smanio [23] claimed that although the calculated effects of Mo on the driving force leads to an expected accelerated kinetic of the bainite formation, a negligible retardation influence of bainite formation kinetics makes the effect of Mo on this transformation unclear. Thus, the influence of Mo on bainite transformation requires more attention.

Based on the viewpoint gained from experimental data, one can conclude that it is difficult to reach microstructure features other than ferrite and pearlite in such low carbon microalloyed steels. The aim of this study was to evaluate the microstructural evolutions of a cast microalloyed steel in a conventionally heat treated condition by means of Mo addition in order to enhance the hardenability and improve the mechanical properties like toughness and tensile properties. The results of microstructural examination and dilatometry tests allow us to understand the effects of Mo on the bainitic transformation in this steel.

## 2. EXPERIMENTAL PROCEDURE

A 100 kg capacity induction furnace was used for steel making. Microalloying elements were added to the melts in the form of ferrovanadium and ferroniobium with concentration of 80 wt. % V and 65 wt. % Nb, respectively. Optical Emission Spectrometry (OES) technique was applied on site during the steel making to measure the chemical composition. The base composition for the casts was adjusted to include about 0.12wt% C and 1.2wt% Mn. The molten steels were deoxidized by Al shot before casting. Mo-added alloy was obtained by the addition of ferromolybdenum (with concentration of 65 wt. % Mo), which had been placed in the bottom of a carrying ladle. Pouring the molten steel (the same melt used for the base steel) into the ladle ensured

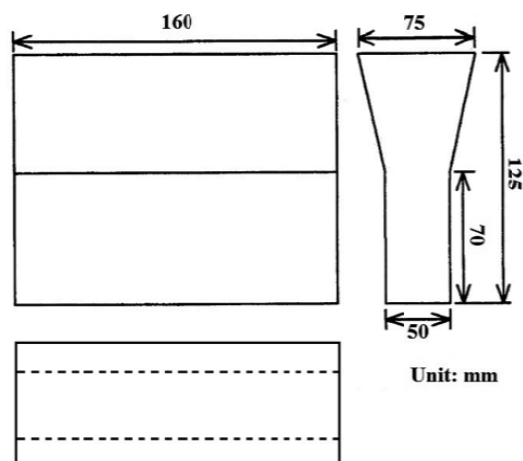

Fig. 1. Scheme of the cast Y-block ingot.

obtaining almost the same base composition for the steels while one of alloys contained Mo. Casting process was performed by pouring the melt into the sand molds with Y-block cavities inside. The size and shape of the Y-block ingot are schematically illustrated in Figure 1. Table 1 shows the chemical compositions of the base and Mo-added microalloyed steels.

All of the casts were homogenized at 1100°C for 5h and then normalized at 950°C for 30 min. Austenitization was done at 1050°C for 30 min. Then, one group of samples experienced oil quenching while another group was air-cooled till reaching the room temperature.

The metallographic samples were polished and then etched using Nital 2% solution. Microstructural examination was done on the micrographs taken by Scanning Electron Microscopes (SEM:Hitachi S 4800 J and QUANTA 450) and also Optical Microscope (OM).

The effects of Mo addition on the hardenability of cast microalloyed steels were

Table 1. chemical composition of the investigated steels

Steels	Elements(wt%)											
	C	Si	Mn	P	S	Al	Ni	Cr	V	Nb	Mo	Fe
Base	0.13	0.25	1.24	0.03	0.02	0.05	0.22	0.89	0.14	0.06	-	Bal.
Base+Mo	0.12	0.23	1.19	0.03	0.02	0.06	0.27	0.99	0.15	0.06	0.30	Bal.

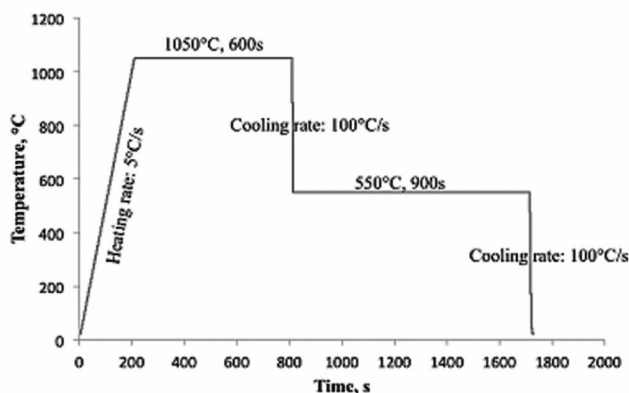

Fig. 2. Heat treatment cycle performed by dilatometer.

investigated by standard Jominy tests on the normalized samples [24]. In addition, dilatometry technique was applied to perform the isothermal treatment on the samples to pursue the effects of Mo on the phase transformation behaviors and also kinetic of the transformations. Dilatometry samples experienced the heat treatment regime presented in Figure 2 by using a high resolution dilatometer (model: 805 DIL Bahr Plastodilatometer).

Impact tests were performed at least three times at room temperature using a WOLPERT testing machine (model AMSLER D-6700) on the air-cooled Charpy samples prepared according to ASTM: E23 [25].

Hardness test was done by using Vickers indenter at 30 kgf load. The tests were done at least five times on each sample and the average was reported.

Tensile tests were performed on the air-cooled samples according to ASTM: E8 [26] by using GOTECH AL-7000 LA 30 tensile machine to measure the yield (YS), Ultimate Tensile Strength (UTS) and also elongation of these samples.

### 3. RESULTS AND DISCUSSION

#### 3. 1. Microstructural Examination

In the cast and homogenized conditions,

microstructures of the samples were coarse enough to perform normalizing treatment on the heats in order to obtain finer and almost same grain sizes in the steels (20 $\mu$ m).

Microstructures of the oil-quenched samples can be observed in Figure 3a and b. It is illustrated that the microstructure features of two samples are almost the same (mainly consist of bainite and martensite). This is derived from the fact that cooling rate of oil medium has been faster than the critical cooling rate for these two steels and the effect of Mo addition could not be clearly tracked in this case. The same result has been reported earlier by Kong and his coworker [12]. Hereupon, another group of the normalized samples experienced the air cooling after austenitization in order to monitor any possible effects of Mo on the microstructure of these samples.

Figure 4 indicates that the microstructures of the base and Mo-containing steels include quite different components in the air-cooled condition. In fact, the microstructure of the base steel includes only ferrite and pearlite, while the microstructure of Mo-added steel is significantly finer and mainly consists of acicular features, which are believed to be bainite. SEM observations (Figure 5a and b) revealed the same microstructural components similar to those shown in Figure 4, where the microstructure of the Mo-added steel contains much finer features

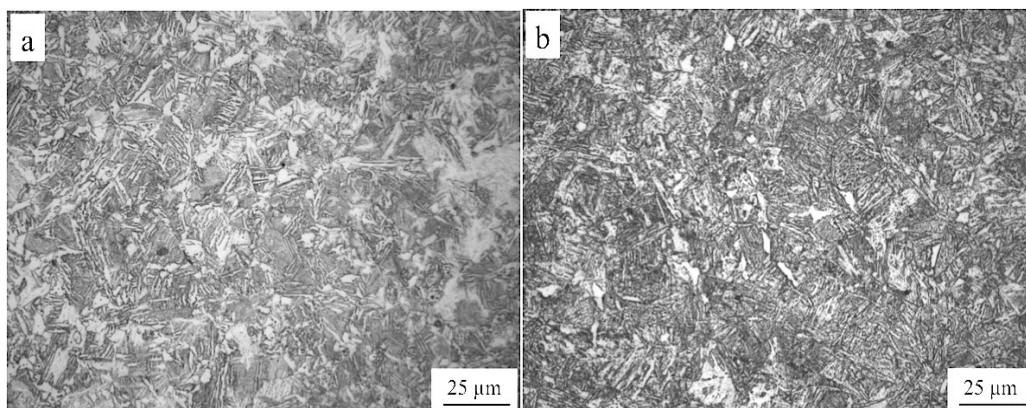

Fig. 3. Optical microstructures of the oil-quenched a) base and b) Mo-added steels.

compared to the base steel. It can be seen in Figure 4b and Figure 5b that the microstructure of the Mo-added steel includes mainly bainite and also small amounts of pearlite. One can say that the rate of air cooling have been slower than the critical cooling rate for the base steel while Mo could decrease the critical cooling rate of the micro-alloyed steel which results in obtaining microstructural components other than pearlite.

### 3. 2. Jominy Test

In Jominy test, different parts of specimen experience various cooling rates through its length. Quenching by water happens at one end of the specimen while air cooling takes place at another side. Microstructural evolutions of

Jominy sample for the base and Mo-added steels are illustrated in Figure 6 and Figure 7, respectively. It can be seen from Figure 6a and Figure 7a that martensite formed at the water quenched end and the volumetric ratio of this phase in this area is almost 100% for both samples. By moving from the water quenched end toward the other end of the Jominy sample, cooling rate decreases and microstructures vary through the length of the samples (Figure 6b-d and Figure 7b-d). Although it is known that Mo has a greater influence on retardation of pearlitic transformation than bainitic, it can be seen that bainite formation started at the distance of 5mm in the base steel (Figure 6b) while the same microstructure formed in Mo-added steel at the distance of 15mm (Figure 7c). In addition, at

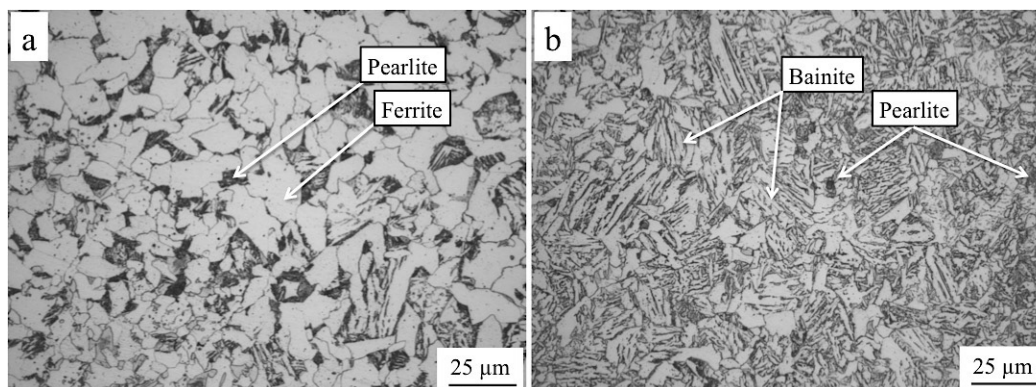

Fig. 4. Optical micrographs of the air-cooled samples indicating a) ferrite-pearlite in the microstructure of the base and b) mainly bainite in microstructure of the Mo-added steels.

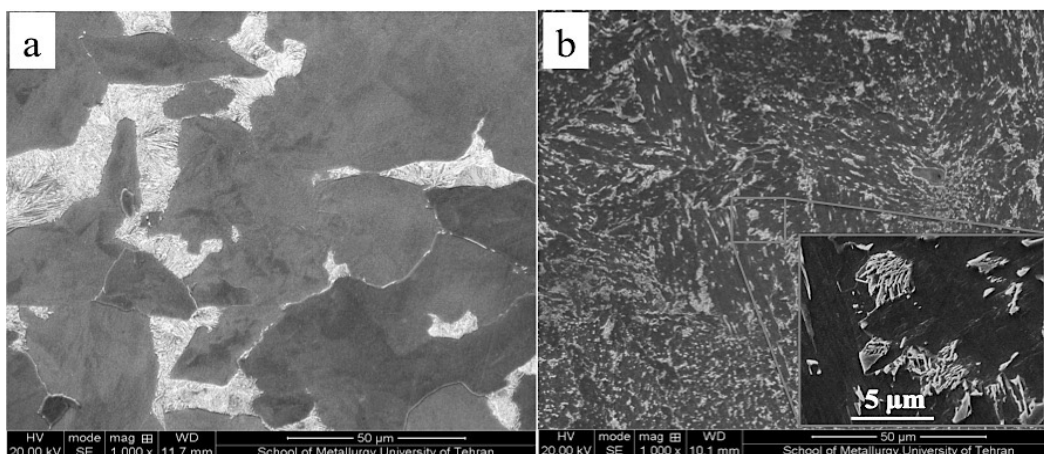

Fig. 5. SEM micrographs of air cooled samples showing the a) coarse ferrite-pearlite microstructure in base steel and b) bainite and small amounts of pearlite (enlarged part of the image) in Mo-added steel.

30mm from the quenched end, microstructure of base steel includes just ferrite and pearlite (Figure 6d), while at the same distance, other different phases than ferrite-pearlite can be observed in the microstructure of Mo-added steel (Figure 7d) which are similar to the microstructures observed in Figure 4b.

Figure 8 shows the hardness profile with respect to the distance from the quenched end of the Jominy samples. There is a decline in the hardness from the water-quenched end of the samples (with martensite) to the air-cooled side of the samples (far from quenched side) with ferrite-pearlite and mainly bainitic features in the

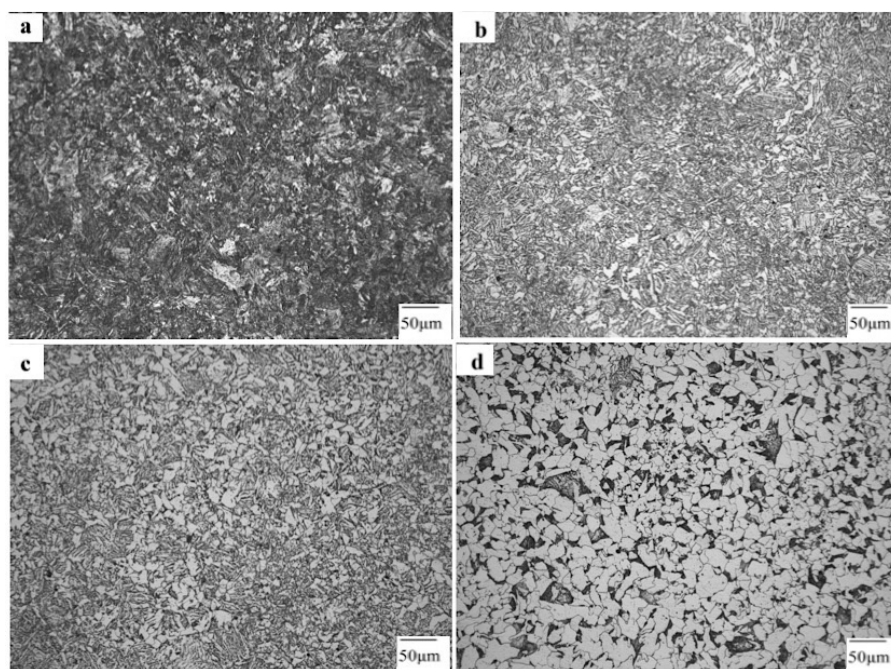

Fig. 6. Microstructures of the base steel at a distance of a) 1mm, b) 5mm, c) 15mm and d) 30mm from quenched end of the Jominy sample.

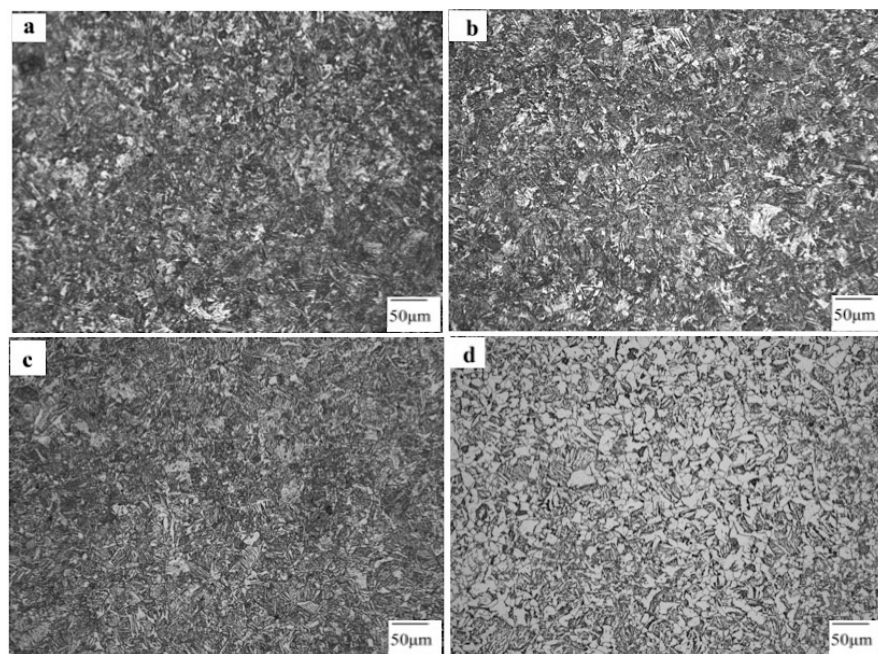

Fig. 7. Microstructures of the Mo-added steel at a distance of a) 1mm, b) 5mm, c) 15mm and d) 30mm from quenched end of the Jominy sample.

base and Mo-added steels, respectively. These variations in the hardness values are mainly attributed to the microstructural evolutions in the Jominy samples due to the different cooling rate from austenitization temperature through their length. The highest hardness values obviously belonged to the quenched end and it can be seen in this figure that hardness of Mo-added steel is a little higher than that of base steel, which could be related to the solution hardening and the effect of Mo on the precipitation behavior [7]. As mentioned above, another possibility is that Mo is able to decrease the  $M_s$  temperature and consequently martensite forms at lower temperature with higher hardness values.

The hardness profiles show that in Mo-added steel, hardness drop occurs with a delay in contrast to the base steel. Also it can be observed that for the base steel, hardness values drop sharply and considerably right after a short distance from the quenched end while for the Mo-added steel the rate of the decrease is slower. In addition, these curves show that the hardness of the specimens seems to reach a fixed value at a distance of 32mm and 27mm from the quenched end for the Mo-added and base steels,

respectively. Moreover, it is clear that the hardness values at the distance far enough from the quenched end is higher for Mo-added steel compared to the base steel which is contributed to the microstructures of these steels in air-cooled condition (Figure 4 b and Figure 7d).

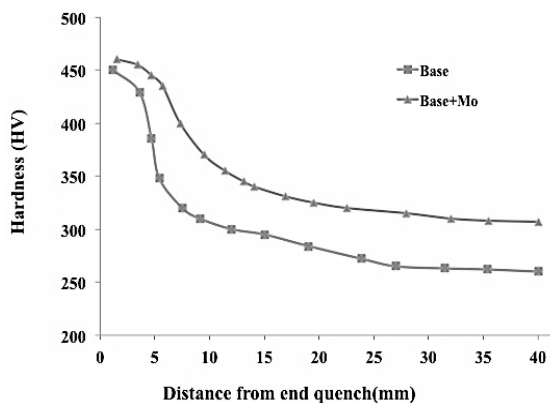

Fig. 8. Hardness versus distance from the water quenched end of the Jominy samples.

### 3. 3. Dilatometry Test

The effect of Mo addition on hardenability was also investigated by dilatometry tests in bainite region for both steels.

Figure 9 reveals the dilatometry graphs of the base and Mo-added steels which experienced the heat treatment cycle presented in Figure 2. It can be seen that more isothermal dimensional changes at about 550°C (bainitic transformation) can be detected in the base steel compared to the Mo-added steel. In the base steel, more bainitic transformation caused untransformed austenite to enrich in carbon content, which resulted in lower Ms temperature compared to the Mo-added steel. Likewise, during the fast cooling from isothermal temperature, more martensitic transformation (dimensional change) would occur in Mo-added steel (Figure 9) because of higher fraction of untransformed austenite.

Figure 10 illustrates the microstructures of the dilatometry samples. Although the microstructure of the base steel contains martensite beside bainite, as expected, more martensite fraction can be seen in Mo-added steel (Figure 10b). These features can be seen more clearly in SEM micrographs (Figure 11) where the fraction of martensite in Mo-added steel seems to be higher than that in the base steel. In fact, Mo enhances the stability of austenite and causes higher fraction of untransformed austenite through isothermal treatment leading to more martensitic transformation as the sample reaches the Ms

temperature afterwards. This phenomenon can be attributed to the effect of Mo on T<sub>0</sub> temperature, which in turn means more stability of austenite (strengthening of austenite) in Mo-added steel compared to the base steel [27].

Kinetic graphs of the isothermal bainitic transformation are shown in Figure 12 starting from the time that the samples reached the isothermal temperature. It can be apprehended from these graphs that Mo addition slightly increased the incubation time for bainitic transformation. But in kinetic graphs of this transformation, it is clear that Mo addition could separate the graphs of the base and Mo-added steels for several seconds. These graphs also show that the isothermal bainitic transformation stopped at about 20 and 60 seconds after reaching

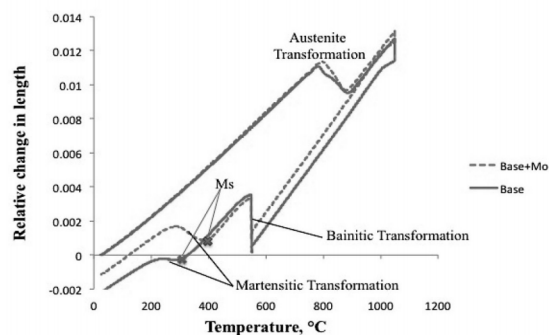

Fig. 9. Dilatometry graphs of the isothermally heat treated steels.

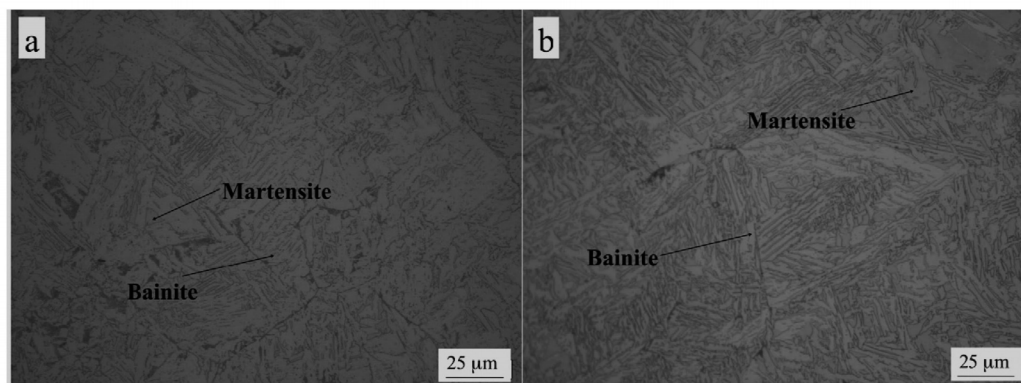

Fig. 10. Microstructure of the dilatometry samples, a) base and b) Mo-added steels.

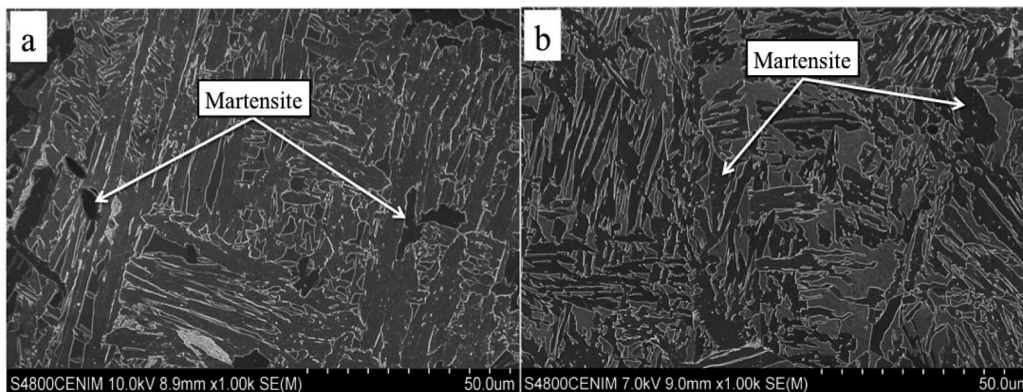

Fig. 11. SEM images showing the microstructure of the isothermally heat treated a) base and b) Mo-added steels.

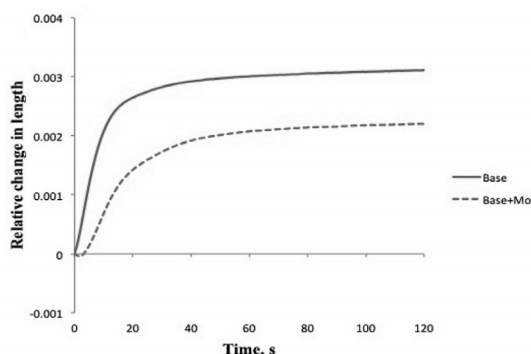

Fig. 12. kinetic graphs of the bainitic transformation for the investigated steels.

the isothermal temperature for the base and Mo-added steels, respectively. This fact implies that more isothermal holding time would not result in more bainitic transformation and the graphs come to a steady state. Besides, lower dimensional changes in the Mo-added steel corresponds to lower bainitic transformation in this steel during

the isothermal treatment.

### 3. 4. Mechanical Properties

As discussed above, oil quenching from austenitization temperature resulted in almost the same microstructure components in the base and Mo added steels while the microstructural features were different in air-cooled condition. The results of the mechanical tests performed on air-cooled steels are given in Table 2. From the results indicated in this table, it can be apprehended that compared to the base steel, Mo addition leads to obtaining higher Yield Strength (YS), Ultimate Tensile Strength (UTS) as well as higher hardness values, while the elongation is almost the same for the both steels under investigation. In fact, hardness and strength levels of the micro-alloyed steel increased without deteriorating the elongation as well as impact properties. The reason of the improvement in mechanical properties can be attributed to the presence of bainite in the microstructure of Mo-added steel as well as

Table 2. The results of hardness measurements, tensile and impact tests

Steels	Properties				
	YS, MPa	UTS, MPa	Elongation, %	Impact energy, J	Hardness, HV
Base	486	976	22	23	264
Base+Mo	524	1108	21	28	297



refinement of the microstructure components. As mentioned, the precipitation behavior, typically carbides/ nitrides/ carbonitrides of the microalloying elements, can be another reason of strengthening in the presence of Mo, which can act as obstacles to dislocation movement as well as failure barriers leading to higher impact energy and strength concurrently (Table 2). Moreover, Mo can postpone the diffusional transformation to the lower temperature and to the longer time [5, 10] leading to formation of finer components at lower temperature in the microstructure (Figure 5a and b) which would affect the steel properties as well.

#### 4. CONCLUSIONS

The effects of Mo addition on the microstructure and mechanical properties of a low carbon cast microalloyed steel was investigated in conventionally heat treated condition and the results can be summarized into the following statements.

1. Microstructural examination revealed that the cooling rate of oil quenching is faster than the critical cooling rate for the both investigated steels while air cooling resulted in obtaining different microstructure features in the base and Mo-added steels; the microstructure of the base steel consists of ferrite and pearlite while Mo addition lead to obtaining acicular components (mainly bainite) in the air-cooled condition.
2. The results of Jominy tests show that Mo addition postponed the formation of the different phases through the length of the samples with different cooling rates. The same results were obtained by performing the dilatometry test in bainitic region; Mo addition increased the incubation time and had a retardation effect on bainitic transformation.
3. Minor Mo addition caused higher untransformed austenite through isothermal bainitic transformation, which in turn led to higher fraction of martensite after reaching the Ms temperature during cooling.
4. Compared to the base steel, Mo addition

resulted in higher yield and tensile strengths as well as higher hardness values while elongation and toughness properties had not been deteriorated.

#### REFERENCES

1. Esmailian, M., "The effect of cooling rate and austenite grain size on the austenite to ferrite transformation temperature and different ferrite morphologies in microalloyed steels". IJMSE, 2010, 7, 7-14.
2. Najafi, H., Rassizadehghani, J., Norouzi, S., "Mechanical properties of as-cast microalloyed steels produced via investment casting. Mater". Des., 2011, 32, 656-663.
3. Najafi, H., Rassizadehghani, j., Asgari, S. "As-cast mechanical properties of vanadium/ niobium microalloyed steels". Mater. Sci. Eng., A, 2008, 486, 1-7.
4. Rassizadehghani, J., Najafi, H., Emamy, M., Eslami-Saeen, G., "Mechanical properties of V, Nb-, and Ti-bearing as-cast microalloyed steels". J. Mater. Sci. Technol., 2007, 23, 779-784.
5. Mohrbacher, H., Sun, X., Yong, Q., Dong, H., "MoNb-based alloying concepts for low-carbon bainitic steels". In Advanced steels, The recent scenario in steel science and technology, ed. Weng, Y., Dong, H., Gan, Y., Springer Berlin Heidelberg: Berlin, Heidelberg, 2011, 289-301.
6. Bramfitt, B. L., "Structure/property relationships in irons and steels". second edition, Metals Handbook, ASM International, 1998.
7. Mohrbacher, H., "Principal effects of Mo in HSLA steels and cross effects with microalloying elements". In International Seminar in Applications of Mo in Steels. Beijing, China, 2010.
8. Dehghan Manshadi, A., Zarei Hanzaki, A., Gohmahalle O., "An investigation to bainite formation morphologies in Ni-Cr bearing low carbon steels through thermomechanical processing". IJMSE, 2005, 2, 9-15.
9. Głownia, J.; Kalandyk, B. "Effect of precipitation strengthening in low alloyed Mn-Ni cast steels", J. Mater. Process. Technol., 2008, 207, 147-153.

10. Suikkanen, P., "Development and processing of low carbon bainitic steels". Acta Univ. Oul. C., 2009.
11. Bramfitt, B. L., Marder, A. R., "Effect of cooling rate and alloying on the transformation of austenite". Metall. Trans. 1973, 4, 2291-2301.
12. Kong, J., Xie, C., "Effect of molybdenum on continuous cooling bainite transformation of low-carbon microalloyed steel". Mater. Des., 2006, 27, 1169-1173.
13. Davis, J. R., Alloying: Understanding the basics. ASM International, 2001.
14. Bhadeshia, H. K. D. H., Honeycombe, S. R., "The heat treatment of steels, Hardenability". In Steels (third edition), Butterworth-Heinemann: Oxford, 2006, 167-181.
15. Hu, H., Xu, G., Wang, L., Xue, Z., Zhang, Y., Liu, G., "The effects of Nb and Mo addition on transformation and properties in low carbon bainitic steels". Mater. Des., 2015, 84, 95-99.
16. Chen, X. W., Qiao, G. Y., Han, X. I., Wang, X., Xiao, F. R., Liao, B., "Effects of Mo, Cr and Nb on microstructure and mechanical properties of heat affected zone for Nb-bearing X80 pipeline steels". Mater. Des., 2014, 53, 888-901.
17. Gladman, T., "The physical metallurgy of microalloyed steels". Maney Pub: 1997.
18. Bhadeshia, H., Honeycombe, R., Steels, Microstructure and properties". Butterworth-Heinemann, 2011.
19. Siwecki, T., Eliasson, J., Lagneborg, R., Hutchinson, B., "Vanadium microalloyed bainitic hot strip steels". SIJ Int. 2010, 50, 760-767.
20. Hara, T., Asahi, H., Uemori, R., Tamehiro, H., "Role of combined addition of niobium and boron and of molybdenum and boron on hardenability in low carbon steels". ISIJ international, 2004, 44, 1431-1440.
21. Tanaka, T., Enami, T. I., "Metallurgical variables involved in controlled rolling of high tensile steels and its application to hot strip". Tetsu-to- Hagane, 1972, 58, 1775-1790.
22. Fadel, A., Glišić, D., Radović, N., Drobnjak, D., "Influence of Cr, Mn and Mo addition on structure and properties of V microalloyed medium carbon steels". J. Mater. Sci. Technol., 2012, 28, 1053-1058.
23. Sourmail, T., Smanio, V., "Low temperature kinetics of bainite formation in high carbon steels". Acta Mater, 2013, 61, 2639-2648.
24. Chandra, B., Kandpal, A., Chutani, A., Gulia, H., Sadanna, CH., "A review on Jominy and determination of effects of alloying elements on hardenability of steel using jominy and quench test". IJAET, 2011., 1, 65-71.
25. ASTM E 23-02a. In Standard Test Methods for Notched Bar Impact Testing of Metallic Materials, 2003.
26. ASTM E 8m-04. In Standard Test Methods for Tension Testing of Metallic Materials, 2004.
27. Bhadeshia, H. K. D. H., "Bainite in steels: Transformations, microstructure and properties". Second edition, Institute of Materials, 2001.