



Optimal H_2 / H_∞ Consensus Based on Particle Swarm Optimization Method to Stability of Third-Order Self-Driving Car Platoons Under External Disturbance

Hossein Chehardoli*

Department of Mechanical Engineering, Ayatollah Boroujerdi University, Boroujerd, Iran

ARTICLE INFO

Article history:

Received : 5 Jul 2023

Accepted: 29 Aug 2023

Published: 17 Sep 2023

Keywords:

H_2 and H_∞ norms

Optimal robust controller

Self-driving car platoon (SDCP)

Particle swarm optimization (PSO)

stability

ABSTRACT

In this article, the optimal robust H_2 / H_∞ control of self-driving car platoons (SDCPs) under external disturbance is investigated. By considering the engine dynamics and the effects of external disturbance, a linear dynamical model is presented to define the motion of each self-driving car (SDC). Each following SDC is in direct communication with the leader. By utilizing the relative position of following SDCs and the leader, the error dynamics of each SDC is calculated. The particle swarm optimization (PSO) method is utilized to find the optimal control gains. To this aim, a cost function which is a linear combination of H_2 and H_∞ norms of the transfer function between disturbance and target variables is constructed. By employing the PSO method, the cost function will be minimized and therefore, the robustness of the controller against external disturbance is guaranteed. It will be proved that under the presented robust control method, the negative effects of disturbance on system performance will significantly reduce. Therefore, the SDCP is internally stable and subsequently, each SDC tracks the motion of the leader. In order to validate the proposed method, simulation examples will be presented and analyzed.

1. Introduction

The virtual coupling of self-driving cars (SDCs) in which each SDC communicates information with its neighbors is called car platooning which is recognized as a special kind of cooperative multi-agent systems (CMASs) [1]. The main aim in the control of self-driving car platoons (SDCPs) is to stabilize the motion of connected SDCs while maintaining a safe optimal distance between them [2, 3]. By organizing motion of SDPs and controlling their velocity, it will be possible to keep intervehicle distances at a desired value in order to increase highways' capacity, enhance the fuel efficiency and improve the quality of traffic flow [4, 5].

All cars in an SDP are coupled together and therefore, behavior of each SDC and the external

disturbance applied to it will affect other SDCs motion in which the spacing errors will increase and amplify [6, 7]. In an SDP, in addition to the stability of individual SDCs, the stability of the group motion is also important, which is called internal stability [8]. Another concept of stability is proposed, which is based on the non-proliferation of tracking error in the platoon. In other words, when disturbance is applied to the leading SDC, the magnitude of the tracking error in the following SDCs will not increase. This type of stability is called string stability [9, 10].

In past decades, substantial research works have been donated to control and stability of SDPs which led to a diversity of outcomes in the researches. These researches fall into several different categories and their purpose is to fulfill all or part of the following objectives: internal

*Corresponding Author

Email Address: h.chehardoli@abru.ac.ir
<https://doi.org/10.22068/ase.2023.649>

stability [10, 11], string stability [12], car following [13], safety of motion [10, 14], comfort of passengers [15, 16], large-scale SDCPs [17], robust performance against noise [18] and disturbance [19], uncertainty estimation [20], scalability [21], lane changing problem [15, 22], increasing highway capacity [10, 23], network attack prevention [24, 25], time delay analyses [26], fault tolerant performance [27], stability in the presence of actuator saturation [28] and actuator faults [29], finite-time stability [30], stabilization of complex [31] and switching networks [32], improving stability margin [33] and system performance in the presence of data loss [34], etc.

Different works have been done in the field of robust control of SDCPs. In [35], a robust controller against uncertain nonlinearities and time delay is devised for second-order nonlinear SDCPs. Robust adaptive sliding mode control (SMC) of third-order SDCPs is the subject of [36]. A novel robust SMC is designed in [37] to attain the string stability of SDCPs in both transient and steady state motion. A combination of artificial neural networks (ANNs) and SMC to disturbance rejection is the main idea of [38]. An adaptive consensus method which is robust under size-varying and uncertain dynamics of SDCPs is proposed in [39].

One idea to design a robust control against disturbance is to minimize the transfer function between the disturbance and the output of system. This objective can be achieved by different methods such as norm 2 (H_2) or norm infinity (H_∞) minimization of this transfer function. If we minimize the H_∞ norm of a signal, its maximum amplitude will reduce and if we minimize the H_2 norm, the average value of it will decrease. By doing this, the effect of disturbance on target states will be reduced and as a result, the system will be robust against external disturbance. In this paper, by considering the engine dynamics, a third-order linear model (in terms of position) which is under external disturbance is used to define each SDC motion. The communication structure is centralized uni-directional in which each car is in direct communication only with the leader. In other words, each SDC receives the position and velocity of the leader and therefore, has access to relative position and velocity with respect to leader. The position error is defined as the difference between each SDC's position and the leader position. Based on this definition, the error dynamics of each SDC is calculated. A

linear feedback controller utilizing both relative position and velocity is introduced to guarantee stability of individual SDC and whole of SDCP. To use advantages of H_2 and H_∞ controllers simultaneously, we combine both of them and constitute a linear cost function. By using the particle swarm optimization (PSO), this cost function is minimized and consequently, the optimal control gains will be obtained. In order to evaluate this method, simulation studies are investigated. In summary, the most important novelty of this paper is designing a linear optimal controller in which the optimal gains are calculated by minimizing the cost function which is a linear combination of H_2 and H_∞ norms. By doing so, the transfer function between target states and disturbance will be reduced through optimal gains obtained by particle swarm optimization which means the robust performance of the SDCP.

The continuation of the article is organized as below. In part 2, the problem definition and preliminaries are introduced. In part 3, the control design procedure is presented. Part 4 describes the optimization process design. Part 5 considers related simulation studies. Finally, the article is concluded by part 6.

2. System formulation

Figure 1 illustrates a SDCP of a leading SDC and N following SDCs. Each SDC is in direct communication with leader and receives its position and velocity. x_0 and v_0 are position and velocity of leader, l_i is the length of SDC i and s is a constant value. The leader dynamical equation is described as:

$$\ddot{x}_0(t) = \varphi_0(t) \tag{1}$$

In which $x_0(t)$ is position of leader and $\varphi_0(t)$ is a determined function. The motion of i -th SDC is describe through the below equation (it should be noted that other nonlinear effects such as tire dynamics, cornering dynamics, etc. are compensated by the lower-level dynamics [3]):

$$\mathcal{G}_i \dot{a}_i(t) + a_i(t) = u_i(t) + w_i(t) \tag{2}$$

where \mathcal{G}_i is time constant of engine, $a_i(t)$, $u_i(t)$ and $w_i(t)$ are acceleration, control law and external disturbance associated with the i -th SDC. The position error of i -th SDC is defined by:

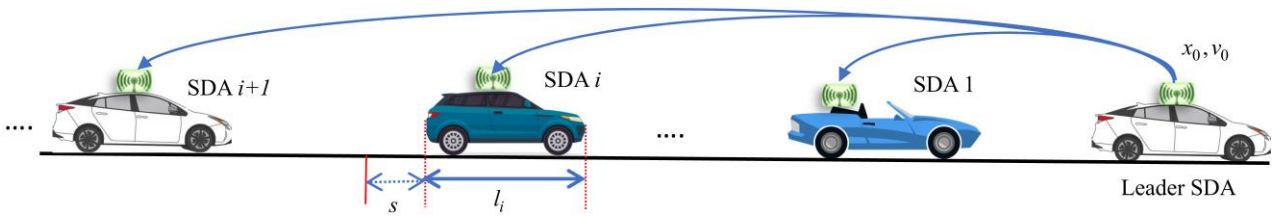

Figure 1: An SDGP with a centralized network and non-identical cars

$$e_i(t) = x_0(t) - x_i(t) - is - \sum_{j=1}^{i-1} l_j \quad (3)$$

Accordingly, one can write:

$$\begin{aligned} \dot{e}_i(t) &= v_0(t) - v_i(t), \\ \ddot{e}_i(t) &= \dot{\varphi}_0(t) - \dot{a}_i(t), \\ \dddot{e}_i(t) &= \ddot{\varphi}_0(t) - \ddot{a}_i(t) \end{aligned} \quad (4)$$

Combining (2), (3) and (4) yields the following error dynamics of the i -th SDC.

$$\begin{aligned} \mathcal{G}_i \ddot{e}_i(t) + \ddot{e}_i(t) &= -u_i(t) - w_i(t) + \mathcal{G}_i \dot{\varphi}_0 + \dot{\varphi}_0 \Rightarrow \\ \ddot{e}_i(t) + \alpha_i \dot{e}_i(t) &= \beta_i u_i(t) + \beta_i \bar{w}_i(t) \end{aligned} \quad (5)$$

where $\alpha_i = 1/\mathcal{G}_i$, $\beta_i = -1/\mathcal{G}_i$ and $\bar{w}_i(t) = \mathcal{G}_i \dot{\varphi}_0 + \dot{\varphi}_0 - w_i(t)$.

3. Control design

In this section, a state feedback consensus control method is introduced to achieve the stability of the SDGP.

By defining that:

$$e_i = r_1, \dot{e}_i = r_2, \ddot{e}_i = r_3 \quad (6)$$

It is worth-noting that since Eq. (2) is a third-order model (in term of position), we need three error variables. The state-space representation of (5) will be derived as below:

$$\dot{\mathbf{r}}(t) = \mathbf{A}_i \mathbf{r}(t) + \mathbf{B}_i \bar{w}_i(t) + \mathbf{B}_i u_i(t) \quad (7)$$

where $\mathbf{A}_i = \begin{pmatrix} 0 & 1 & 0 \\ 0 & 0 & 1 \\ 0 & 0 & -\alpha_i \end{pmatrix}$ and $\mathbf{B}_i = \begin{pmatrix} 0 \\ 0 \\ \beta_i \end{pmatrix}$. We

define the following target states:

$$z_1(t) = \eta_1 e(t), \quad z_2(t) = \eta_2 \dot{e}(t) \quad (8)$$

where η_1 and η_2 are positive values that $\eta_1, \eta_2 > 1$. Therefore, the dynamical equation of the i -th SDC by considering the output and target states is written as follows:

$$\begin{pmatrix} \dot{\mathbf{r}}(t) \\ \mathbf{z}(t) \\ \mathbf{y}(t) \end{pmatrix} = \begin{pmatrix} \mathbf{A}_i & \mathbf{B}_i & \mathbf{B}_i \\ \mathbf{C}_1 & \mathbf{0} & \mathbf{0} \\ \mathbf{C}_2 & \mathbf{0} & \mathbf{0} \end{pmatrix} \begin{pmatrix} \mathbf{r}(t) \\ \bar{w}_i(t) \\ u_i(t) \end{pmatrix} \quad (9)$$

where $\mathbf{C}_1 = \begin{pmatrix} \eta_1 & 0 & 0 \\ 0 & \eta_2 & 0 \end{pmatrix}$, $\mathbf{C}_2 = \begin{pmatrix} 1 & 0 & 0 \\ 0 & 1 & 0 \end{pmatrix}$ and $\mathbf{z}(t) = \begin{pmatrix} z_1(t) \\ z_2(t) \end{pmatrix}$.

The transfer function of the open-loop system will be obtained as below:

$$\begin{aligned} \Gamma(s) &= \begin{pmatrix} \mathbf{C}_1 \\ \mathbf{C}_2 \end{pmatrix} (s\mathbf{I} - \mathbf{A}_i)^{-1} (\mathbf{B}_i \quad \mathbf{B}_i) = \\ &= \begin{pmatrix} \Gamma_{11}(s) & \Gamma_{12}(s) \\ \Gamma_{21}(s) & \Gamma_{22}(s) \end{pmatrix} = \begin{pmatrix} \Gamma_{zd}(s) & \Gamma_{zu}(s) \\ \Gamma_{yd}(s) & \Gamma_{yu}(s) \end{pmatrix} \end{aligned} \quad (10)$$

where

$$\begin{aligned} \Gamma_{11}(s) = \Gamma_{12}(s) &= \mathbf{C}_1 (s\mathbf{I} - \mathbf{A}_i)^{-1} \mathbf{B}_i = \\ &= \begin{pmatrix} \eta_1 \beta_i / s^2 (s + \alpha_i) \\ \eta_2 \beta_i / s (s + \alpha_i) \end{pmatrix} \end{aligned} \quad (11)$$

$$\begin{aligned} \Gamma_{21}(s) = \Gamma_{22}(s) &= \mathbf{C}_2 (s\mathbf{I} - \mathbf{A}_i)^{-1} \mathbf{B}_i = \\ &= \begin{pmatrix} \beta_i / s^2 (s + \alpha_i) \\ \beta_i / s (s + \alpha_i) \end{pmatrix} \end{aligned} \quad (12)$$

The following state feedback control is designed for the i -th SDC:

$$u_i(t) = k_1 e_i(t) + k_2 \dot{e}_i(t) \quad (13)$$

Figure 2 describes the controller and the closed-loop block-diagram of i -th SDC.

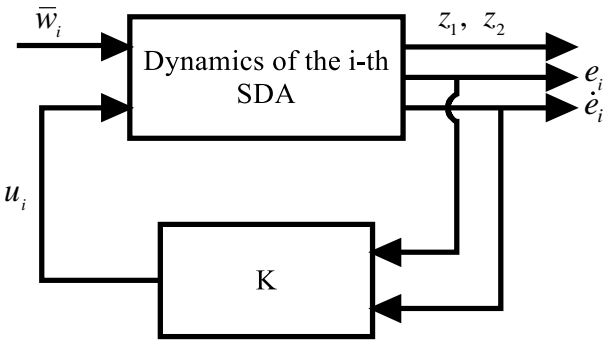

Figure 2: Closed-loop dynamics of i -th SDC

The necessary, but not sufficient condition for stability of (5), is its stability without disturbance. Replacing (13) in (5) and neglecting disturbance yields to:

$$\mathcal{G}_i \ddot{e}_i(t) + \ddot{e}_i(t) + k_2 \dot{e}_i(t) + k_1 e_i(t) = 0 \quad (14)$$

By taking the Laplace transform of (14) and utilizing the Routh-Hurwitz technique, we find that under the below condition, the SDCP is asymptotic stable without disturbance:

$$k_2 > k_1 \mathcal{G}_i \quad (15)$$

4. Optimal performance using particle swarm optimization (PSO)

In the early 1990s, various researches were conducted on the social behavior of animal groups. These researches indicated that some animals that belong to a certain group, such as birds, fishes and others, are able to share information within their groups and such ability to these animals. It conferred significant survival benefits. Inspired by these studies, Kennedy and Eberhart introduced the Particle Swarm Optimization (PSO) algorithm in an article in 1995 [40]. The PSO algorithm is a metaheuristic algorithm that is suitable for optimizing non-linear continuous functions. The authors of the mentioned article have inspired and created the PSO algorithm from the concept of particle intelligence which usually exists in groups of animals such as herds and packs of animals.

The condition (15) is necessary but not sufficient for the stability of the proposed SDCP. To achieve stability, the effect of disturbance on target states should be reduced as much as possible. To this aim, the magnitude of the closed-loop transfer function between the disturbance and the target states should be decreased. By combining (10) to (13), the closed-loop transfer

function between $\mathbf{z}(t)$ and $\bar{w}_i(t)$ is obtained as below:

$$T_{zd}(s) = \Gamma_{11}(s) + \Gamma_{12}(s) \mathbf{K} (\mathbf{I} - \Gamma_{22}(s) \mathbf{K})^{-1} \Gamma_{21}(s) \quad (16)$$

To reduce the magnitude of the above transformation function, the H_2 or H_∞ norms can be considered. By reducing the H_∞ norm, the maximum magnitude of $T_{zd}(j\omega)$ will decrease. On the other hand, if H_2 norm be reduced, the average magnitude of $T_{zd}(j\omega)$ will be decreased. Here we want to take advantage of both H_2 and H_∞ norms. Therefore, we define the following cost function which is a linear combination of H_2 and H_∞ norms:

$$CF = \nu \|T_{zd}(j\omega)\|_2 + (1-\nu) \|T_{zd}(j\omega)\|_\infty \quad (17)$$

where ν is a positive value such that $0 < \nu < 1$.

To obtain the optimal values of gains k_1 and k_2 , we employ the PSO method. By minimizing (17) through PSO, the optimal gains are obtained.

5. Method validation

In this part, simulation studies are offered to verify the proposed technique.

5.1. Simulation results

For simulation study, we consider a SDCP with 10 following SDCs and a leader. The specifications of the SDCs are as below:

$$\begin{aligned} \mathcal{G} &= 0.1 \text{ s}^{-1}, l_i = 4.2 \text{ m}, s = 8 \text{ m}, k_1 = 2.4, \\ k_2 &= 2.3, w(t) = 0.005\nu + 0.001\nu^2 \end{aligned} \quad (18)$$

Distance error between two successive SDCs is defined as:

$$r_i(t) = x_i(t) - x_{i-1}(t) - l_{i-1} - s \quad (19)$$

Moreover, we choose $\nu = 0.5$. In other words, the weights of both H_2 and H_∞ norms are equal.

First case study. We consider a zero-acceleration motion of leader according to the following:

$$\varphi_0(t) = 0, \quad v_0(t) = 20 \text{ m/s} \quad (20)$$

The initial velocities of following SDCs are chosen arbitrarily as follows:

$$\begin{aligned}
 [v_1, v_2, v_3, v_4, v_5, v_6, v_7, v_8, v_9, v_{10}]_{t=0} &= \\
 &= [10, 15, 5, 12, 8, 17, 22, 25, 19, 24] \text{ m/s}
 \end{aligned}
 \tag{21}$$

Distance error of SDCs is plotted in Figure 4. This figure shows the stability of SDCP since the distance errors tend to a small region around the origin. The position of each SDC is depicted in Figure 5. According to Figure 5, distance between all neighbor SDCs is positive. So that, we have no collision between SDCs. Velocity of all SDCs is shown by Figure 6. As we infer from this figure, all SDCs reach the velocity of leader.

Second case study. A movement with positive acceleration is assumed for leading car according to the following profile:

$$\varphi_0(t) = \begin{cases} 1, & 0 \leq t < 10 \\ 0, & \text{else} \end{cases}, \quad v_0(0) = 10 \text{ m/s}
 \tag{22}$$

All initial positions and velocities are same as previous example. Figure 6 depicts the distance error of SDCs and Figure 7 shows the velocity of all cars. These figures confirm the stability of the SDCP. Moreover, the instant position of cars is plotted in Figure 8. This figure infers that the collision is prevented in the SDCP's motion.

Second case study. A movement with negative acceleration is assumed for leading car according to:

$$\varphi_0(t) = \begin{cases} -1, & 0 \leq t < 10 \\ 0, & \text{else} \end{cases}, \quad v_0(0) = 10 \text{ m/s}
 \tag{23}$$

All initial positions and velocities are same as the previous case study. The results are presented through Figures 9 – 11.

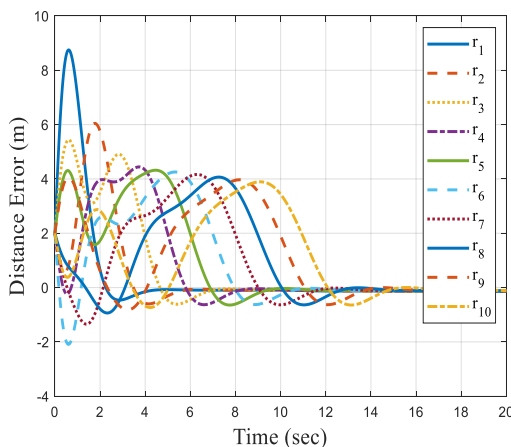

Figure 3: Distance error of first case study

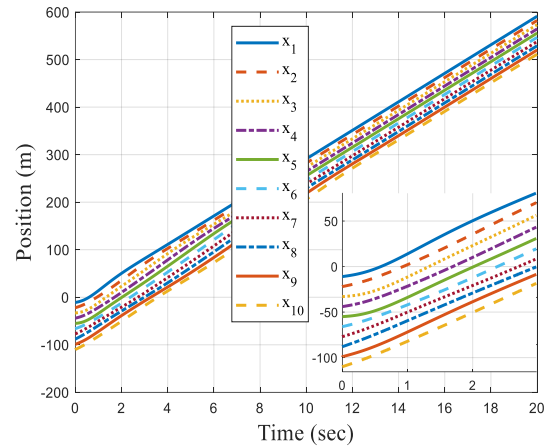

Figure 4: Position of SDCs of first case study

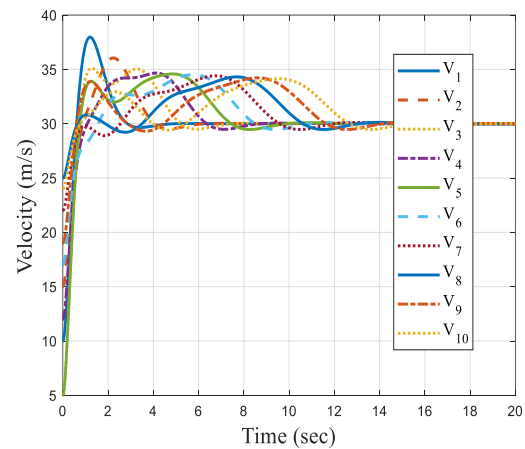

Figure 5: Velocity of first case study

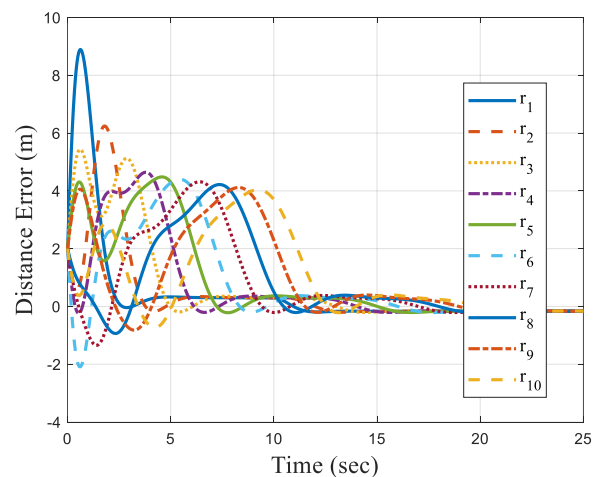

Figure 6: Distance error of second case study

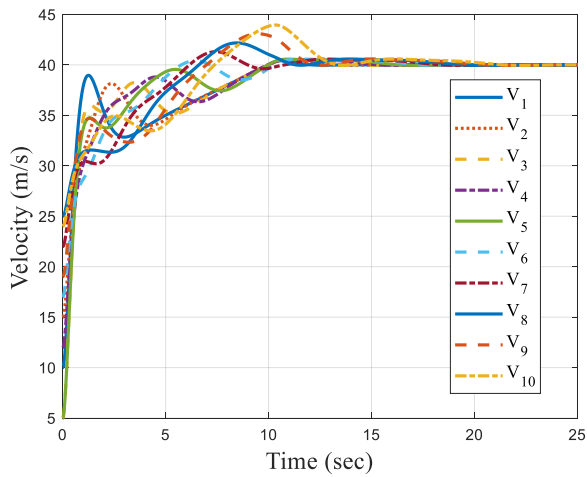

Figure 7: Velocity of second case study

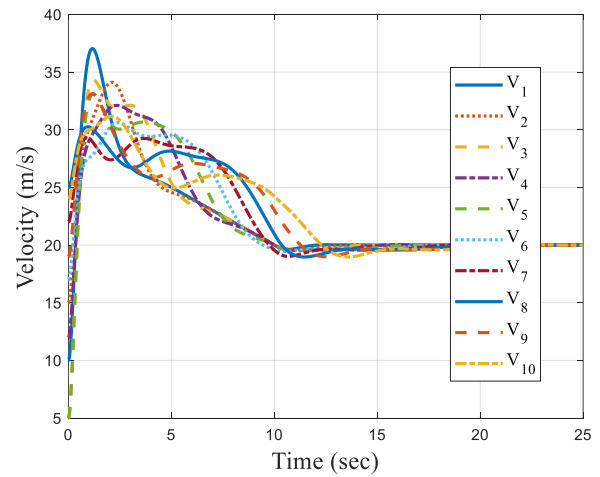

Figure 10: Velocity of third case study

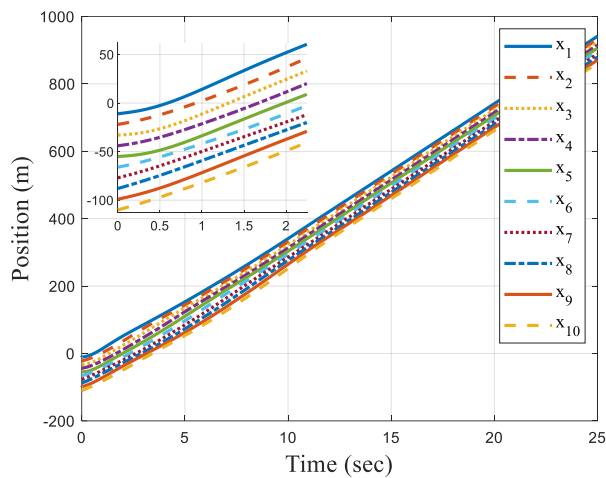

Figure 8: Position of second case study

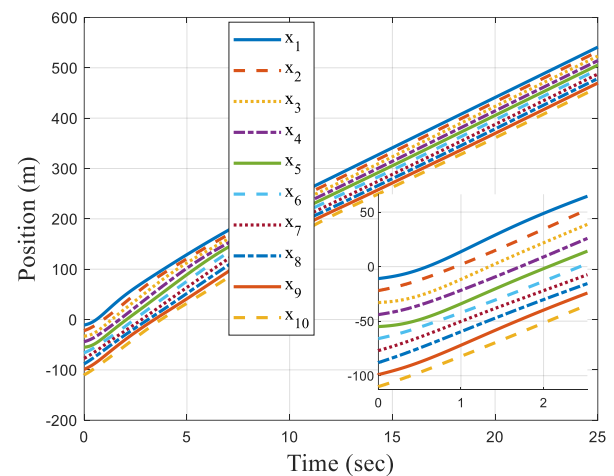

Figure 11: Position of third case study

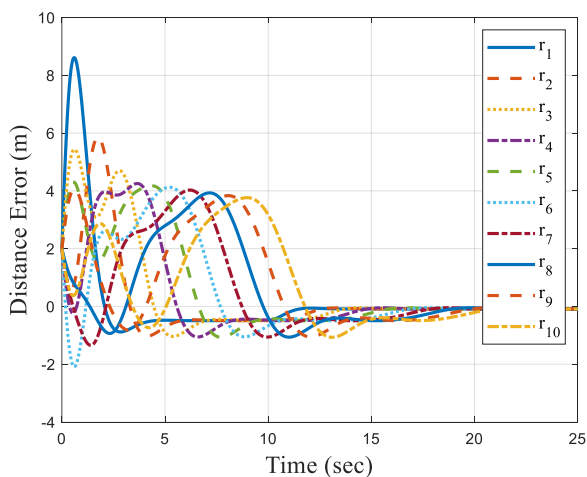

Figure 9: Distance error of third case study

6. Conclusions

The problem of robust optimal H_2 / H_∞ control of SDCPs under external disturbance was studied in this paper. It was assumed that each SDC communicates directly with the leader and has access to its position and velocity. The main objective was designing a robust controller to weaken the effect of external disturbance on the target states and the outputs of the SDCP. To this aim, we defined a cost function which was a linear combination of H_2 and H_∞ norms of the transfer function between disturbance and target states. By employing the PSO, the optimal control gains which minimized the cost function were derived. To show the merits of this method, different numeric studies were presented. For future works, the LQR method can be employed to design an optimal controller. The results of LQR can be compared with this paper.

References

- [1] C. Bergenheim, S. Shladover, E. Coelingh, C. Englund, and S. Tsugawa, "Overview of platooning systems," in *Proceedings of the 19th ITS World Congress, Oct 22-26, Vienna, Austria (2012)*, 2012.
- [2] A. Ghasemi, R. Kazemi, and S. Azadi, "Stability analysis of longitudinal control of a platoon of vehicles by considering lags subject to communication delay," *The International Journal of Innovative Computing, Information and Control*, vol. 10, no. 5, pp. 1625-1641, 2014.
- [3] R. Rajamani, *Vehicle dynamics and control*. Springer Science & Business Media, 2011.
- [4] H. Ge, R. Cheng, and L. Lei, "The theoretical analysis of the lattice hydrodynamic models for traffic flow theory," *Physica A: Statistical Mechanics and its Applications*, vol. 389, no. 14, pp. 2825-2834, 2010.
- [5] J. Wang, X. Luo, W. Wong, and X. Guan, "Specified-Time Vehicular Platoon Control With Flexible Safe Distance Constraint," *IEEE Transactions on Vehicular Technology*, vol. 68, no. 11, pp. 10489-10503, 2019, doi: 10.1109/TVT.2019.2939558.
- [6] S.-L. Dai, S. He, H. Lin, and C. Wang, "Platoon formation control with prescribed performance guarantees for USVs," *IEEE Transactions on Industrial Electronics*, vol. 65, no. 5, pp. 4237-4246, 2017.
- [7] Y. Ma, Z. Li, R. Malekian, R. Zhang, X. Song, and M. A. Sotelo, "Hierarchical fuzzy logic-based variable structure control for vehicles platooning," *IEEE Transactions on Intelligent Transportation Systems*, vol. 20, no. 4, pp. 1329-1340, 2018.
- [8] J. Zhang, T. Feng, F. Yan, S. Qiao, and X. Wang, "Analysis and design on intervehicle distance control of autonomous vehicle platoons," *ISA Transactions*, vol. 100, pp. 446-453, 2020.
- [9] L.-Y. Hao, P. Li, and G. Guo, "String stability and flow stability for nonlinear vehicular platoons with actuator faults based on an improved quadratic spacing policy," *Nonlinear Dynamics*, vol. 102, no. 4, pp. 2725-2738, 2020/12/01 2020, doi: 10.1007/s11071-020-06094-4.
- [10] Y. Bian, Y. Zheng, W. Ren, S. E. Li, J. Wang, and K. Li, "Reducing time headway for platooning of connected vehicles via V2V communication," *Transportation Research Part C: Emerging Technologies*, vol. 102, pp. 87-105, 2019.
- [11] S. Santini, A. Salvi, A. S. Valente, A. Pescapé, M. Segata, and R. L. Cigno, "A consensus-based approach for platooning with intervehicular communications and its validation in realistic scenarios," *IEEE Transactions on Vehicular Technology*, vol. 66, no. 3, pp. 1985-1999, 2016.
- [12] C. Wang and H. Nijmeijer, "String stable heterogeneous vehicle platoon using cooperative adaptive cruise control," in *2015 IEEE 18th International Conference on Intelligent Transportation Systems*, 2015: IEEE, pp. 1977-1982.
- [13] J. Bao, Y. Cui, H.-d. He, P.-j. Zheng, and H.-x. Ge, "A modified control method for congested traffic in car-following model," *International Journal of Dynamics and Control*, vol. 3, pp. 457-462, 2015.
- [14] S. M. Mohtavipour, M. Mollajafari, and A. Naseri, "A guaranteed-comfort and safe adaptive cruise control by considering driver's acceptance level," *International Journal of Dynamics and Control*, vol. 7, no. 3, pp. 966-980, 2019/09/01 2019, doi: 10.1007/s40435-018-0500-5.
- [15] H. Liu and R. Jiang, "Improving comfort level in traffic flow of CACC vehicles at lane drop on two-lane highways," *Physica A: Statistical Mechanics and its Applications*, vol. 575, pp. 1-9, 2021.
- [16] P. A. Cook, "Stable control of vehicle convoys for safety and comfort," *IEEE transactions on automatic control*, vol. 52, no. 3, pp. 526-531, 2007.
- [17] J. Zhou and F. Zhu, "Analytical analysis of the effect of maximum platoon size of connected and automated vehicles," *Transportation Research Part C: Emerging Technologies*, vol. 122, pp. 1-21, 2021.
- [18] T. Meng, Y. Xie, and Z. Lin, "Consensus of second-order multi-agent systems under unknown but bounded measurement noises," *Systems & Control Letters*, vol. 133, p. 104517, 2019.
- [19] S. Li, X. Nian, and Z. Deng, "Distributed optimization of general linear multi-agent systems with external disturbance," *Journal of the Franklin Institute*, vol. 358, no. 11, pp. 5951-5970, 2021.
- [20] A. Prayitno and I. Nilkhamhang, "Distributed Model Reference Adaptive Control for Vehicle Platoons with Uncertain Dynamics," *Engineering Journal*, vol. 25, no. 8, pp. 173-185, 2021.
- [21] L. Xiao, F. Gao, and W. Jiangfeng, "On scalability of platoon of automated vehicles for leader-predecessor information framework," in *2009 IEEE Intelligent Vehicles Symposium*, 3-5 June 2009 2009, pp. 1103-1108, doi: 10.1109/IVS.2009.5164436.
- [22] Y. Liu, H. Wang, and C.-Y. Dong, "A Centralized Cooperative Lane-Changing Strategy for Merging into CAV Platoon," in *CICTP 2023*, 2023, pp. 1803-1815.
- [23] Y. Li *et al.*, "Variable time headway policy based platoon control for heterogeneous connected vehicles with external disturbances," *IEEE Transactions on Intelligent Transportation Systems*, vol. 23, no. 11, pp. 21190-21200, 2022.

- [24] Z. Zhou, F. Zhu, D. Xu, S. Guo, and Y. Zhao, "Attack resilient control for vehicle platoon system with full states constraint under actuator faulty scenario," *Applied Mathematics and Computation*, vol. 419, p. 126874, 2022.
- [25] D. Zhang, Y.-P. Shen, S.-Q. Zhou, X.-W. Dong, and L. Yu, "Distributed secure platoon control of connected vehicles subject to DoS attack: Theory and application," *IEEE Transactions on Systems, Man, and Cybernetics: Systems*, vol. 51, no. 11, pp. 7269-7278, 2020.
- [26] M. Di Bernardo, A. Salvi, and S. Santini, "Distributed consensus strategy for platooning of vehicles in the presence of time-varying heterogeneous communication delays," *IEEE Transactions on Intelligent Transportation Systems*, vol. 16, no. 1, pp. 102-112, 2014.
- [27] G. Guo, P. Li, and L.-Y. Hao, "Adaptive fault-tolerant control of platoons with guaranteed traffic flow stability," *IEEE Transactions on Vehicular Technology*, vol. 69, no. 7, pp. 6916-6927, 2020.
- [28] G. Guo, P. Li, and L. Y. Hao, "A New Quadratic Spacing Policy and Adaptive Fault-Tolerant Platooning With Actuator Saturation," *IEEE Transactions on Intelligent Transportation Systems*, vol. 23, no. 2, pp. 1200-1212, 2022, doi: 10.1109/TITS.2020.3023453.
- [29] X. Liu, M. Yan, P. Yang, and J. Song, "Observer-based Actuator Fault Detection and Robust Tolerant Control for Vehicle Platoons," *International Journal of Control, Automation and Systems*, vol. 21, no. 4, pp. 1175-1186, 2023/04/01 2023, doi: 10.1007/s12555-021-0920-4.
- [30] G. Guo, J. Kang, H. Lei, and D. Li, "Finite-Time Stabilization of a Collection of Connected Vehicles Subject to Communication Interruptions," *IEEE Transactions on Intelligent Transportation Systems*, pp. 1-9, 2021.
- [31] M. Herrera, M. Pérez-Hernández, A. Kumar Parlikad, and J. Izquierdo, "Multi-agent systems and complex networks: Review and applications in systems engineering," *Processes*, vol. 8, no. 3, p. 312, 2020.
- [32] P. Wang, H. Deng, J. Zhang, L. Wang, M. Zhang, and Y. Li, "Model predictive control for connected vehicle platoon under switching communication topology," *IEEE Transactions on Intelligent Transportation Systems*, vol. 23, no. 7, pp. 7817-7830, 2021.
- [33] P. Barooah, P. G. Mehta, and J. P. Hespanha, "Mistuning-based control design to improve closed-loop stability margin of vehicular platoons," *IEEE Transactions on Automatic Control*, vol. 54, no. 9, pp. 2100-2113, 2009.
- [34] W. Yue, L. Wang, Z. Liu, Y. Xi, and X. Guan, "Sampled-data internet of connected vehicles control with channel fading and time-varying delay," *Mechanical Systems and Signal Processing*, vol. 135, p. 106430, 2020.
- [35] F. Gao, S. E. Li, Y. Zheng, and D. Kum, "Robust control of heterogeneous vehicular platoon with uncertain dynamics and communication delay," *IET Intelligent Transport Systems*, vol. 10, no. 7, pp. 503-513, 2016.
- [36] G. Guo and D. Li, "Adaptive sliding mode control of vehicular platoons with prescribed tracking performance," *IEEE Transactions on Vehicular Technology*, vol. 68, no. 8, pp. 7511-7520, 2019.
- [37] X. Guo, J. Wang, F. Liao, and R. S. H. Teo, "Distributed adaptive integrated-sliding-mode controller synthesis for string stability of vehicle platoons," *IEEE Transactions on Intelligent Transportation Systems*, vol. 17, no. 9, pp. 2419-2429, 2016.
- [38] J. Wang, X. Luo, Y. Zhang, and X. Guan, "Distributed integrated sliding mode control via neural network and disturbance observer for heterogeneous vehicle systems with uncertainties," *Transactions of the Institute of Measurement and Control*, p. 01423312221143655, 2023, doi: 10.1177/01423312221143655.
- [39] Hossein Chehardoli and A. ghasemi, "Robust Adaptive Consensus of Decentralized Large-Scale Bi-Directional Vehicular Platoons with Only Relative Position Measurement," *IEEE Transactions on Vehicular Technology*, vol. 71, pp. 1-10, 2022, doi: 10.1109/TVT.2021.3134749.
- [40] R. Eberhart and J. Kennedy, "Particle swarm optimization," in *Proceedings of the IEEE international conference on neural networks*, 1995, vol. 4: Citeseer, pp. 1942-1948.