

Crash Test Simulation and Structure Improvement of IKCO 2624 Truck According to ECE-R29 Regulation

R.Mirzaamiri¹, M.Esfahanian², S. Ziaei-Rad³

¹Islamic Azad University, Branch of Majlesi; ²Assistant Professor, ³Professor Isfahan University of Technology.

mesf1964@cc.iut.ac.ir

Abstract

During the design and development of truck cabins, the safety of the driver and the front seat passenger in an accident is an important task and should be considered. The cab must be designed in such a way that in an accident a sufficient survival space is guaranteed. The aim of this study is to investigate the behavior of Iran Khodro (IKCO) 2624 truck subjected to a complex crash test according to regulation ECE-R29. This regulation is a comprehensive European regulation consisting of three tests: 1-Front impact test (Test A), 2-Roof strength test (Test B), 3-Rear wall strength test (Test C). These tests do not consider the safety of the occupant directly; however, a III-50th% dummy was used to assess the cab's deformations relative to the driver survival space. A 3D finite element model of the cab and chassis was developed and subjected to tests by using LS-DYNA software. The results indicate that the cab complied with Test A and C successfully while it passed Test B marginally. Finally, two solutions are suggested and implemented to improve the cab's response for Test B.

Keywords: *Crashworthiness, Finite element method, ECE regulation.*

1. INTRODUCTION

In the past few years, safety issues in truck design have become more and more important. As a result, the computational simulation of impact events and crash test procedures has become of primary importance as it allows the designer to predict the behavior, reach to important conclusions and optimize the structure performance on the very early stage of the development[1].

In several studies the accident details of commercial heavy vehicles were examined [2-5]. According to these studies the highest risk exists in frontal collisions, which lead approximately 75 percent of accidents to injuries of the truck occupants[4].

Here seat belts and airbags can protect against injuries and reinforced cab structures can reduce the risk of getting jammed. In order to exclude the danger of injury of the occupants to a large extent, the driver's cab must be dimensioned in such a way that in cases of a rear end collision, rolling over of the vehicle on the side or on the roof, or by load slipping

in the case of a front impact, the strength and stiffness of the cab structure is sufficient enough to secure the necessary survival space for the occupants.

The ECE-R29 [6] safety standard prescribes uniform provisions concerning the approval of vehicles with regard to the protection of the cab occupants of a commercial vehicle. Its major goals are to evaluate the chassis frame-cab attachment in a situation of head-on impact and the overall cab strength, in order to eliminate to the greatest possible extent the risk of injury to the occupants. This is achieved by guaranteeing a survival space allowing accommodation of a prescribed manikin on the seat. Can be effectively used for optimal design of aluminum foam-filled tubes.

2. Legal requirements of the ECE-R29 Regulation

The legal requirements of cabin safety are fixed in Europe in the regulation ECE-R29. As from 1, October 2002 ECE-R29 approvals can only be granted, when the requirements as specified by the 02 series of amendments are fulfilled. A short description of the tests demanded in this regulation

and the vehicle requirements for fulfilling these tests is given.

As depicted in **Error! Reference source not found.** the ECE-R29 contain a three-part test of the cab:

- Front impact test (test A)
- Roof strength test (test B)
- Rear wall strength test (test C)

Front impact (Test A)

A rigid pendulum with a striking surface of 2500 mm × 800 mm and a mass of 1500 kg ± 250 kg must be so positioned, that in its vertical position the center of gravity is 50 ± 5/0 mm below the R-Point of the driver's seat. This is different to the preceding version of this regulation where the vertical position of the center of gravity was 150 ± 5/0 mm below the R-Point of the driver's seat with a maximum height above ground of 1400 mm. This change leads to the fact that the pendulum now impacts the front panel of the cab in most of vehicle models, while in the preceding version of ECE-R29 mostly the cab suspension or the frame front end was impacted.

The impact energy of the pendulum has to be 30 KJ for vehicles of a permissible maximum weight up to 7000 kg and 45 kJ for vehicles for which the

permissible maximum weight exceeds this value. For IKCO 2624 it equals 45kJ.

Roof strength (Test B)

The roof of the cab has to withstand a static load corresponding to the maximum load authorized for the front axle of the vehicle, subject to a maximum of 10 tones. This load is to be distributed uniformly over all the bearing members of the roof structure by means of a rigid plate. Deformation of the cab suspension shall be eliminated by means of rigid members.

Rear wall strength (Test C)

The rear wall of the cab must withstand a static load of 2kN per ton of the vehicle's permissible payload. This load shall be applied by means of a rigid barrier perpendicular to the longitudinal median axis of the vehicle, covering at least the whole cab rear wall situated above the chassis frame and moving parallel to that axis.

It is left to the manufacturer whether all three tests A, B and C or only the tests A and B are carried out. Furthermore the tests can be carried out successively on the same cabin or in each case with a new cab.

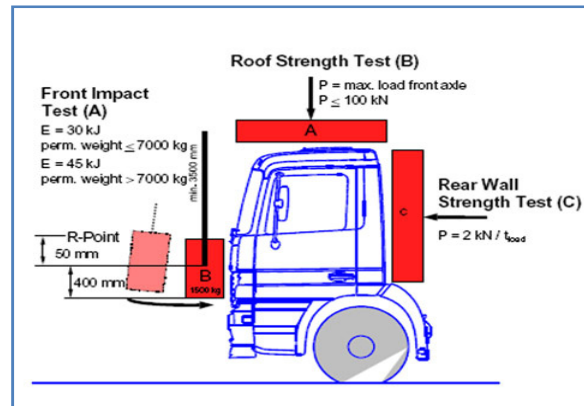

Fig1. Triple tests of ECE.R29

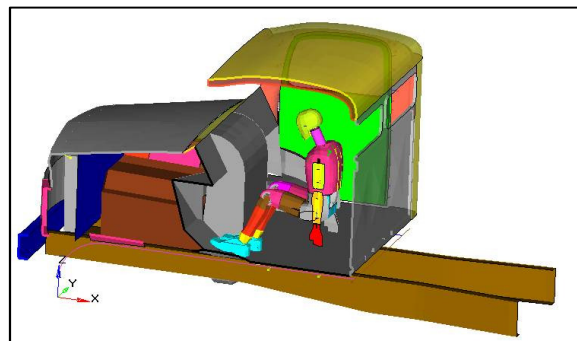

Fig2. Dummy's position in Cab

The cab of the vehicle must be so designed and so attached to the vehicle as to eliminate to the greatest possible extent the risk of injury to the occupants in the event of an accident.

After undergoing each of the tests referred to in above, a survival space has to be present, allowing accommodation of the test dummy defined in ECE-R29 on the seat in the centre position, without contact between the test dummy and non-resilient parts. The survival space so defined has to be verified for every seat provided by the manufacturer. For this goal a III 50th% dummy (a standard dummy for crash testing) must be used (**Error! Reference source not found.**).

During the tests, the parts with which the cab is fastened to the chassis frame may deform or break, as long as the cab remains connected with the frame. The doors may not open during the tests, but the doors shall not be required to be opened after testing.

3. Numerical simulation of the ECE-R29 tests

Numerical analysis

Numerical analysis, in general, attempts to solve the mathematical problems like differential equations by numerical procedures. The differential equation can be split into numerical components in the time axis using the forward, central or the backward differentiation methods. The numerical methods also can be broadly classified as the explicit and the implicit methods. The explicit method calculates the next time step value using the previous time step values, whereas the implicit method calculates the next time step values by solving a matrix of the present and the previous time step values. The explicit method requires shorter time step for an accurate solution, whereas the implicit methods can give reliable results with larger time steps. Also, most of the implicit methods are unconditionally stable, whereas the explicit methods are mostly conditionally stable. In implicit method contact cannot be easily controlled. Hence this method is not used for crash simulation.

Explicit analysis

Nowadays, explicit non-linear finite element method is widely used for simulation of high speed events, especially in vehicle crash testing.

The equations of motion for linear behavior give the linear O.D.E

$$M\ddot{U} + C\dot{U} + KU = f^{external}(t) \tag{1}$$

While the equations for the non-linear behavior give the internal force as a nonlinear function of the displacement leading to non-linear O.D.E

$$M\ddot{U} + C\dot{U} + f^{internal}(u) = f^{external}(t) \tag{2}$$

For some linear O.D.E closed form solutions are possible but for most of non-linear O.D.E only numerical solutions are the only option.

In equation (2), $M, C, U, \dot{U}, \ddot{U}$ are mass matrix, damping matrix, displacement vector, velocity vector and acceleration vector respectively. The equations of motion at any time n are given as

$$M\ddot{U} = -C\dot{U} - f^{internal}(u) + f^{external}(t) \tag{3}$$

To advance the equations in time t_{n+1} , LS-DYNA uses the central time integration.

$$\ddot{U}_n = M^{-1}(f^{external}_n - C\dot{U}_n - f^{internal}_n) \tag{4}$$

The velocity is calculated by

$$\dot{U}_{n+1/2} = \dot{U}_{n-1/2} + \ddot{U}_n \Delta t_n \tag{5}$$

And the displacement by

$$U_{n+1} = U_n + \Delta t_{n+1/2} \dot{U}_{n+1/2} \tag{6}$$

Whereas

$$\Delta t_{n+1/2} = \frac{\Delta t_n + \Delta t_{n+1}}{2} \tag{7}$$

And

$$\Delta t_n = t_{n+1/2} - t_{n-1/2} \tag{8}$$

The scheme of this method is illustrated in **Error! Reference source not found.**

In this method the size of the time step is related to the size of the smallest element L and the wave velocity c of the material.

$$\Delta t \leq \Delta t_{critical} = \frac{2}{\omega} = \frac{L}{c} = \frac{L}{\sqrt{E/\rho}} \tag{9}$$

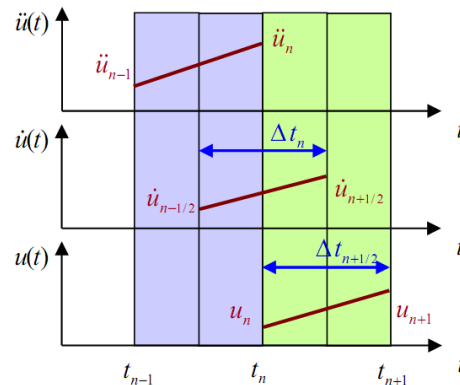

Fig3. Central time integration method

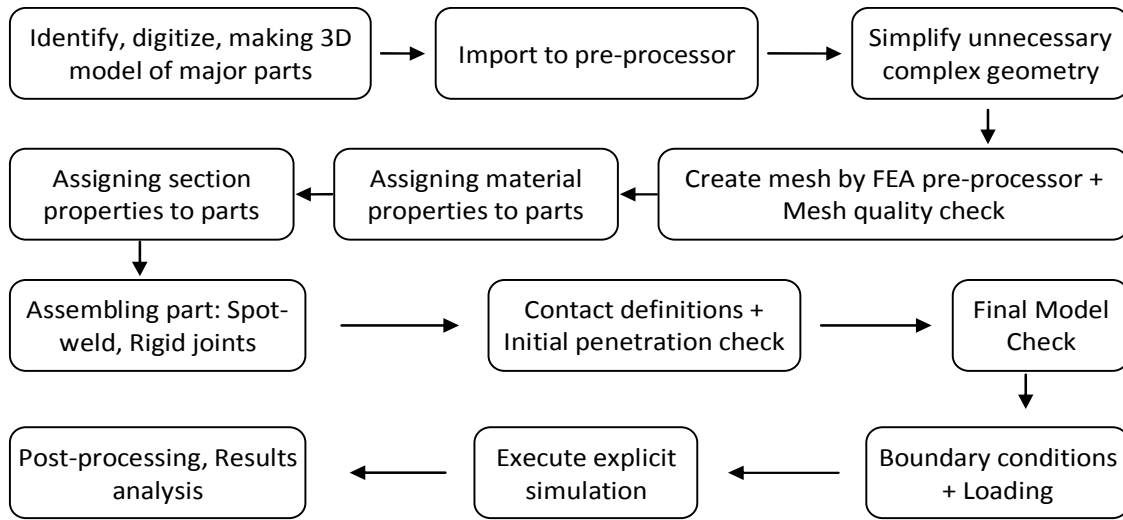

Fig4. Crash simulation stages

While

$$c = \sqrt{E / \rho}; \omega = \sqrt{\frac{k}{m}} \tag{10}$$

The critical time step corresponds to the condition that the computation should not advance faster than a physical phenomenon. It depends on the density and the Young’s modulus. The explicit analysis requires a small time step (around 1 msec) which leads to a large amount of steps.

4. Building 3D model

A crash simulation involves some major steps which are depicted in **Error! Reference source not found..** To obtain reliable results it is crucial to carry out each step precisely and accurately. Due to the lack of design data the reverse engineering process was used to acquire the geometric data of the cab.

A complete 3D model was made by using the following three techniques:

For some parts of the structure an optic digitizer machine was used for making cloud points. Next, the collected data were transferred to CATIA software.

Available 2D drawing of some parts is used to create their 3D models.

The 3D models of some simple parts are made directly by CMM measurement of their dimensions.

Mesh generation and mesh quality

The accuracy in which the crash behavior of a vehicle is simulated depends on the quality of the meshing. The FEM mesh should be fine enough to ensure computational convergence and coarse enough to keep the computational time reasonably low. Also, there are several mesh parameters that affect the results’ accuracy[7].

For meshing purposes, HyperMesh software was used. HyperMesh is a high performance finite element pre- and post-processor that allows building finite element models, views their results, and performs data analysis.

Some qualitative criteria that should be considered in order to have an optimum mesh, are listed as the following[5].



Fig5. Different parts of ECE-R29 truck cabin

- Min Side Length: Length of the smallest side of an element.
- Max Side Length: Length of the largest side of an element.
- Aspect Ratio: Ratio of longest side to the shortest side of an element.
- Warpage: Deviation of an element or element face from being planar.
- Min/Max Quad Internal Angle: The minimum/maximum angle of a quad element.
- Min/Max Triangle Internal Angle: The minimum/maximum angle of a triangle element.
- Percent of Triangular Elements: Ratio of the number of triangular elements to the total number of elements.

The final meshed model of the truck cabin is shown in **Error! Reference source not found.**

5. Material properties

The isotropic elastic-plastic material of parts during the crash has been modeled by means of a linear piecewise plastic code. This code is robust and is able to model many kinds of material specially steels[8]. Also Strain rate effects can be considered in this code (**Error! Reference source not found.**).

In addition, plastic strain 0.2 for failure was defined for steel parts[8].

Components of the truck with negligible deformations such as the engine block were modeled using LS-Dyna Rigid material model. Elements which are rigid are bypassed in the element processing and no storage is allocated for storing their history variables. Thus rigid material type is very cost efficient.

Section Properties

For most of parts, a shell element with the element formulation Belytschko-Lin-Tsay is used. For elements used directly in impacting areas, five integration points through the thickness of the shell were provided. This can more precisely model the shell bending and failure and also prevent phenomenon of hourglass [9]. For elements located in other areas, three integration points were used [10].

Parts assembling

For creating fixed connections between part in assembling process, one of the following three methods have been used[11]:

Merging nodes.

Stitching two part with spot weld element.

Fixing two or more parts by means of rigid constraints.

The primary difference between the spotweld constraints and the rigid-body constraints is the ability to specify a failure criterion for spotwelds. Failure of spotwelds occurs when addition of shear force and normal force at spot weld is greater than effective plastic strain.

We can specify this value in constrained spotweld code and if this value is reached then spotwelds will fail.

$$\left(\frac{f_n}{S_n}\right)^n + \left(\frac{f_s}{S_s}\right)^m \geq 1 \quad (11)$$

Where 'f_n' and 'f_s' are the normal and shear interface force and, 'm', 'n' are exponents for spotweld forces.

Also several revolute joints were provided for hinges (for example hood hinges)[12].

6. Contact modeling

LS-DYNA3D has three algorithms for contact defined as the: kinematic constraint method, the penalty method, and the distributed parameter method.

The penalty method is widely used in crash simulations. This method consists of placing normal interface springs between the master and the slave surface (they are two involved surfaces). The contact algorithm controls if the nodes of a second shell element (Slave) are penetrating the contact surface (master surface). If it accurse, a penalty force F is generated which is proportional to the amount of penetration ('d' in **Error! Reference source not found.**).

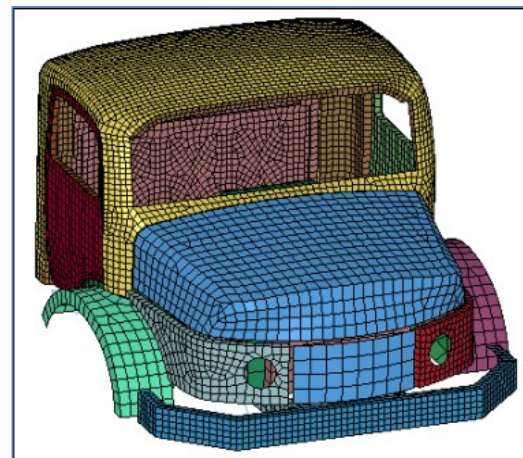

Fig6. Final finite element model of the truck

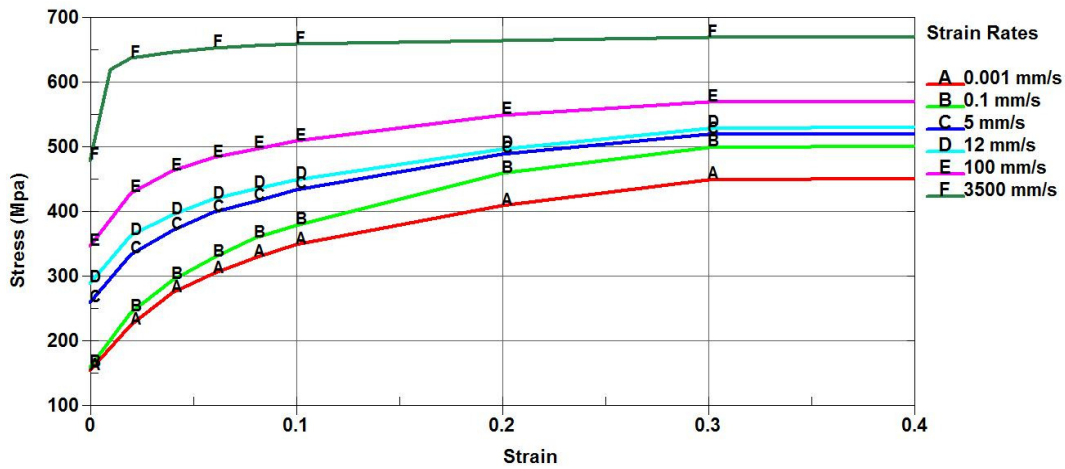

Fig7. Curve table of Stress vs. strain for various strain rates

One consequence of transferring CAD data to FEM models is that some initial penetrations may occur. LS-DYNA can handle small initial penetrations by adjusting the locations of nodes. This introduces some initial localized stress, but it is not a serious problem. Large initial penetrations, however, can cause local stresses to exceed the material’s yield stress. Which is why fixing “Initial Penetrations” is so crucial in the in the “Model Check” stage of simulation.

Contacts handling often takes up to 1/3 of the total computation time, so contacts should be set up efficiently.

In auto crash tests, folding a sheet on itself is commonplace (**Error! Reference source not found.**). To support all kinds of contacts “Self Contact” algorithm often is used in crash simulations

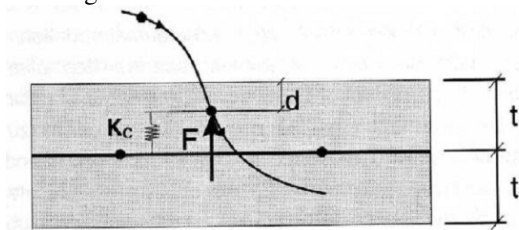

Fig8. Penalty algorithm in contacts

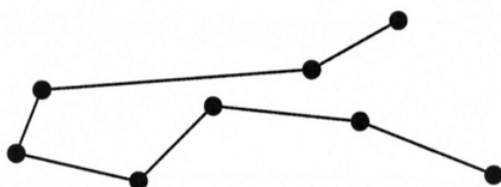

Fig9. Self contact occurs in sheet folding

7. Load Conditions

Front Impact Test

The pendulum was idealized as a shell structure but with rigid property. At the same time only the rotation around the y-axis was set free. The energy of the pendulum was controlled via a special card in LS-Dyna.

The card has an option that allows the inertial properties and initial conditions to be defined rather than calculated from the finite element mesh. This applies to rigid bodies only. The correct length of the pendulum arms was set via the input of the centre of gravity for the rigid body in this card.

Roof and Rear Wall Strength Test

The plate which applies the roof load and/or rear wall load to the structure was also meshed as a rigid shell structure.

The roof crush test was carried out at very low speed (1m/s) and can be regarded as a quasistatic test[13]. This means ignoring strain rate effects and applying the fixed velocity to the ram plate at sufficient low velocity in a way that it won’t induce any dynamic effects[4].

Several analyses showed that by applying the load with a velocity of 1 m/s, a very good agreement with the appropriate test results is achieved.

Modeling with these specifications has resulted in to a workable compromise between accurate deformations and CPU time.

Results of the Numerical Simulation

Front Impact Results (Test A)

Since the truck 2624 possesses an extended front side, a plenty of energy could be dissipated in this area while front crash happened.

The deformation (along longitudinal axis of cab) of a frontal point of structure and some points in the driver compartment are depicted in **Error! Reference source not found.** As showed in the **Error! Reference source not found.**, the maximum displacements of frontal point (belong to the hood) is 320mm (The “Front of HOOD” in **Error! Reference source not found.**) whereas the extreme displacement in the driver compartments is about 52mm which is illustrated by N1 to N4 in **Error! Reference source not found.**

The reason of this difference can be described according to **Error! Reference source not found.** This figure shows the portion of energy that has been dissipated in the frontal parts (like bumper,

fender, radiator, hood ...) and the portion of energy that has been dissipated in the driver compartment (like doors, roof, walls ...). As Indicated in the figure, 94% of the impact energy will be dissipated by frontal parts.

The contour of plastic strain for the structure is shown in **Error! Reference source not found.** Finally, after the front crash, no points of the driver compartment penetrate to the driver space and so the survival space for the driver remained sufficient.

The changes in the energy during Test A are depicted in **Error! Reference source not found.** According to **Error! Reference source not found.**, as contact has started, the kinetic energy of the system decreases whereas the internal energy increases.

Also it is clear that hourglass energy is less than 10% of total energy and thus the obtained results are acceptable [9].

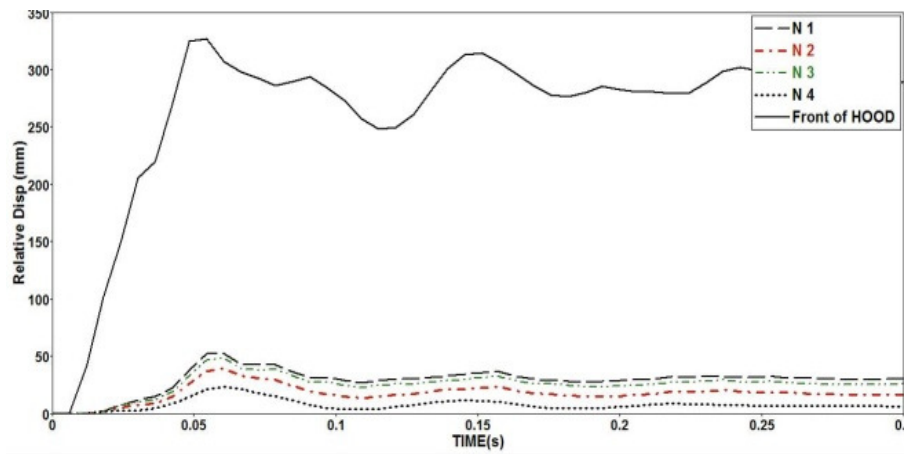

Fig10. Displacements of different cab nodes in Test A

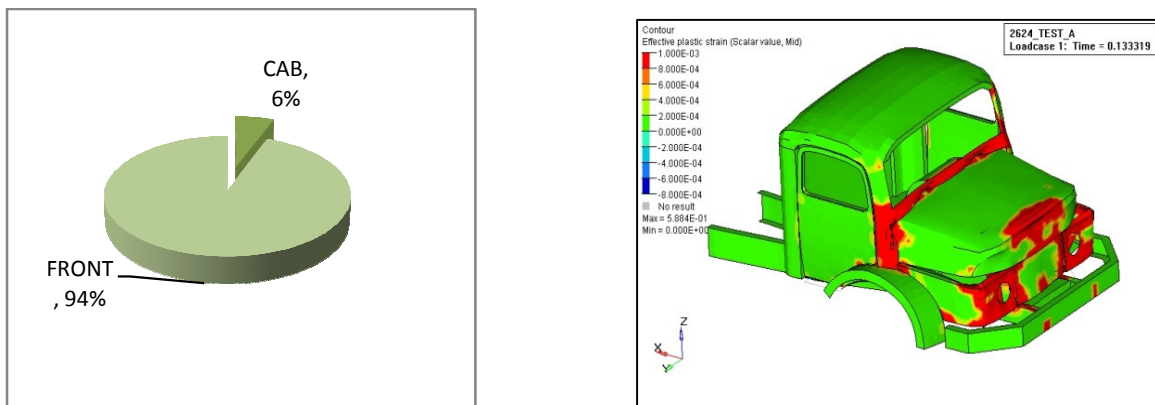

Fig11. Energy ratio dissipation in cab and front parts of the structure

Fig12. Contours of plastic strain (Test A)

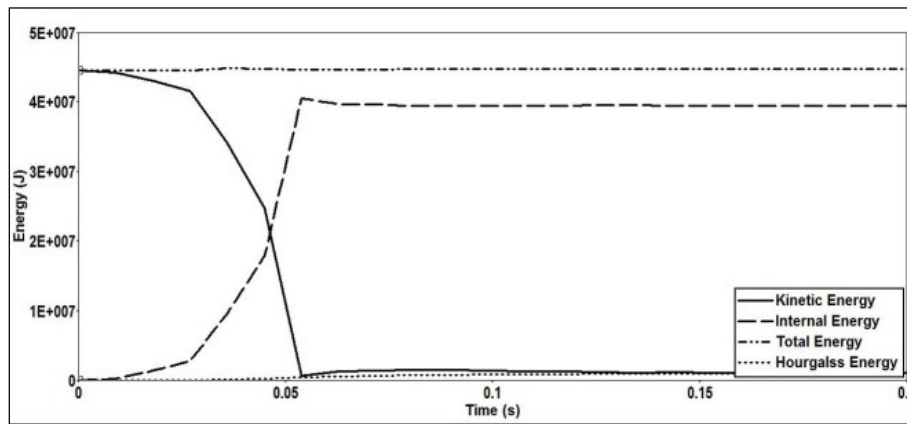

Fig13. Energy variation during Test A

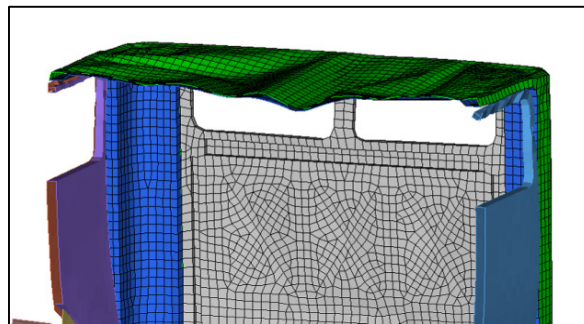

Fig14. Section view; Buckling of the truck roof (Test B)

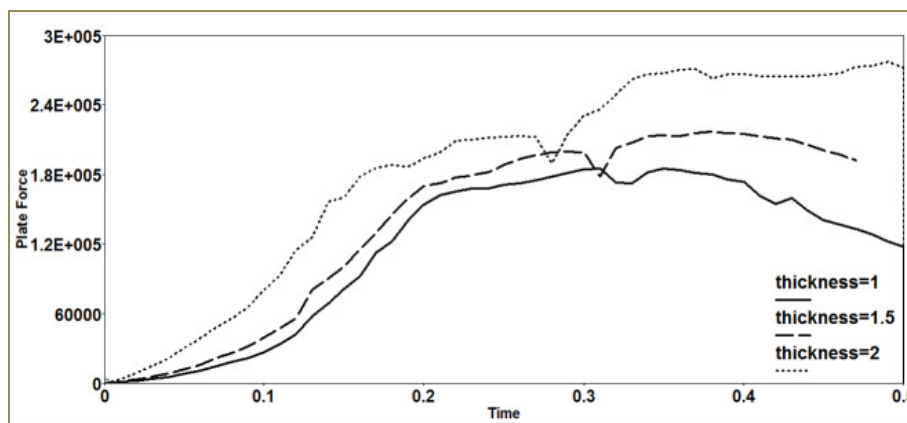

Fig15. (Force vs. Time for rigid plate) The effect of utilizing several thicknesses in roof strength

Roof strength Results (Test B)

The maximally permissible front axle load for the IKCO 2624 is 7 tons. This corresponds to a roof load of 68.67 KN, which has to be put on the roof for simulation of test B. This load causes the roof panel

to intrude into the occupant compartment in the roof lid area.

According to regulation ECE-R29 after the deformation, there should remain a pure survival space above the driver head, which means no parts of the structure are allowed to have any contact with occupant’s head. There are two issues that may cause

violating the regulation in test B; these are buckling of the columns and the double surfaces of roof. Figure depicts the buckling behavior in the backside of the roof and the lateral roof panels during the test.

According to the results, which are obtained through TEST B, it is shown that the survival space for the driver was sufficient, which means there is no head injury. However, roof buckled to permissible threshold. In other words, there is no reliable safety margin in TEST B, that might cause head injures for occupants in reality.

Due to this issue, two approaches were proposed to enhance the dynamic response of structure.

The first approach is to replace the roof shell with

a thicker one. It can reduce buckling not only in the columns but also in roof surfaces.

The original thickness of metal sheets used in the roof and columns is 1 millimeter. In this study also the thicknesses which used in other parts (Back-wall for example) are assessed for using in the roof (i.e. 1.5, 2 mm). The effects of changing the thickness on roof strength are illustrated in **Error! Reference source not found.** Using sheets with 1.5mm thickness can adds 4cm to safety margin, and 2mm thick sheets bring 7cm safety margins. The reduction in buckling of roof surfaces also can be seen in **Error! Reference source not found.**

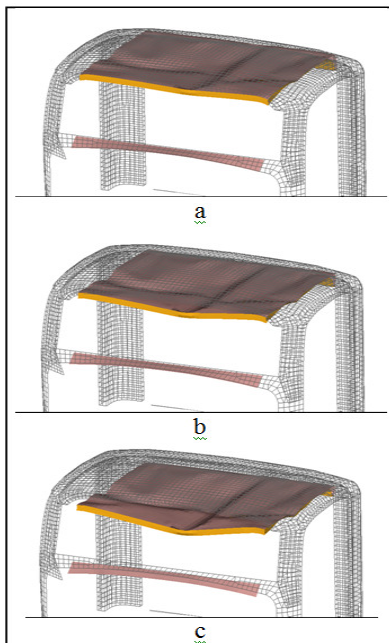

Fig16. Buckling of roof, (a): thickness=1mm (b): thickness=1.5, (c): thickness=2

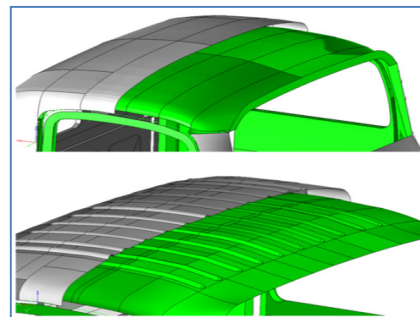

Fig17. Replace ordinary sheets with the rimmed one

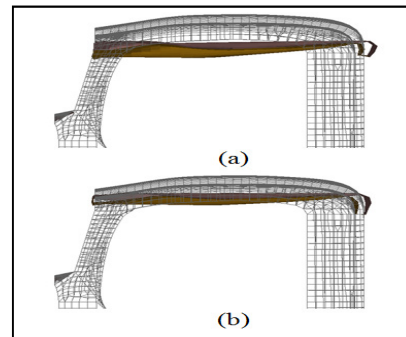

Fig18. Changing of buckling shape, (a): flat surface, (b): Rimmed surface

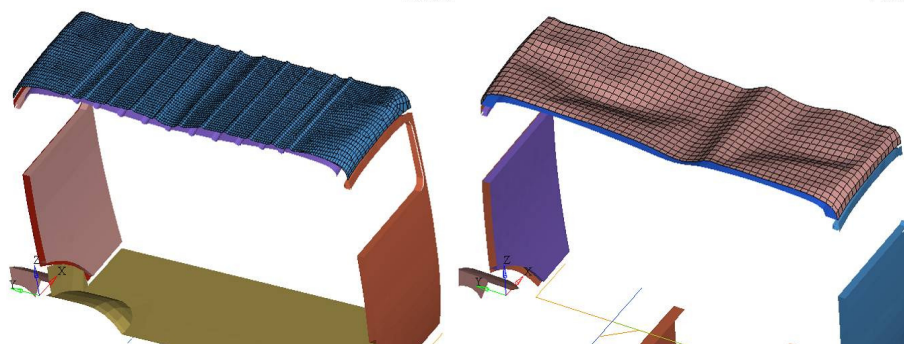

Fig19. Severe local buckling in ordinary roof (Right) vs. uniform buckling in rimmed roof surface (Left)

Although, raising the thickness of sheet metals may increase weight of structure; it quite affects the safety needed for occupant.

The second approach is to replace the flat surface of the roof with a rimmed one as depicted in **Error! Reference source not found.**

These rims are being created during manufacturing process and that has a conventional manufacturing way. The effect of rims on the roof dynamic response is to diminish and postpone the roof buckling. As it is depicted in **Error! Reference source not found.** and **Error! Reference source not found.**, a flat surface and rimmed one have different buckling shape. In conventional roof, during buckling some severe local penetration occurs. As illustrated in **Error! Reference source not found.** (Right), in two areas roof deformation may damage occupant's head, while in rimmed roof uniform deformation happens and there is no local sever penetration (**Error! Reference source not found.**, Left). The rims reduce large deformation in the roof and by deforming them can absorb energy to some extent. This approach reduced maximum penetration by 5cm, so the reformed roof surface has more reliable dynamic response and it remains more safety margins for occupant.

These two solutions can be adopted separately or in combination. The drawback of first approach is weight increasing while rising production costs is the

downside of the second approach. The proper solution can be chosen by the manufacturers through a cost-benefit analysis.

Error! Reference source not found. illustrates the energy balance during Test B. Due to the external work that has been done by rigid plate to the structure, the total energy of the system increases. Since Test B is quasi-static, kinetic energy has minuscule role in this test and major part of inserted energy is absorbed by deformation in roof and column area.

Rear wall strength (Test C)

A load of 34KN corresponding to a maximum payload of 17tons has to be applied for the rear wall strength test. After that, it is to leave a survival space in the occupant's compartment. As depicted in **Error! Reference source not found.** at a specific time the load equal 43KN.

According to **Error! Reference source not found.** the minimum distance between the critical point and the driver seat is equal to 10mm. It is noticeable that the initial distance between the roof and the driver seat was 134mm. Therefore, one can say that there is enough space for survival of the driver.

Error! Reference source not found. shows contours of displacement for the rear wall of the truck.

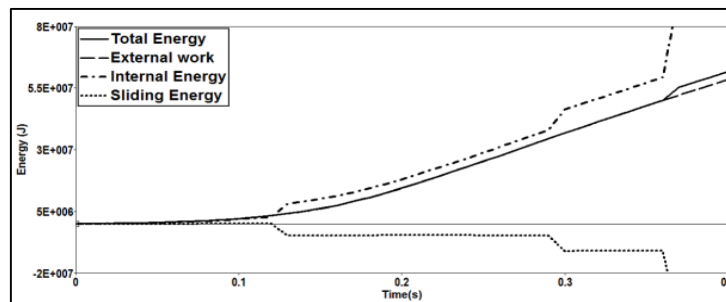

Fig20. Energy changes during Test B

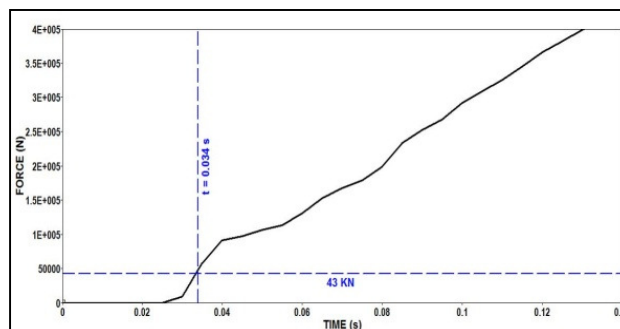

Fig21. Force versus time for rigid plate (Test C)

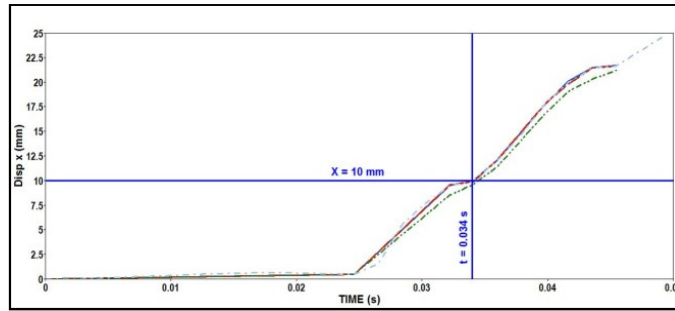

Fig22. Displacement versus time for 4 critical points (TestC)

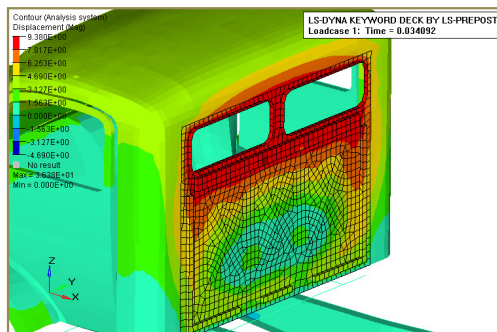

Fig23. Contours of displacement along longitudinal axes of truck (Test C)

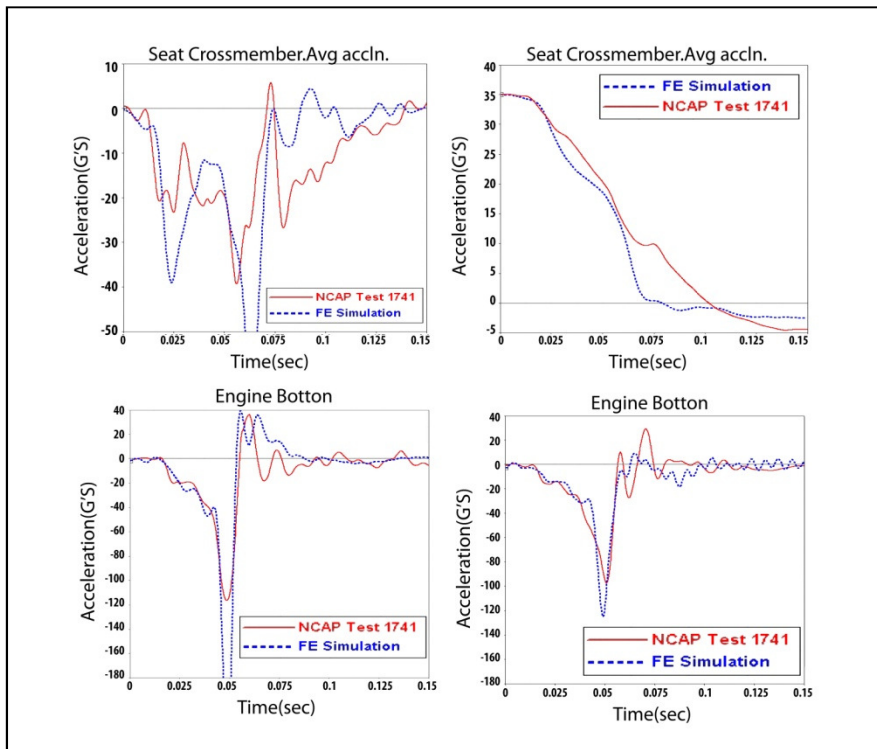

Fig24. Comparison between numerical and experimental results for C1500 Pick-up Truck

8. Model Validation

Since performing a full-scale experimental test is quite costly, especially for heavy vehicle, current research was deprived of experimental results. Therefore, a similar simulation (according to NCAP1 tests) has been carried out on a validated FE model for a C1500 Pick-up Truck. These two simulations have several similarities in basic items such as:

- General geometry of structures
- Shell elements formulation
- Contact algorithm and used codes
- Techniques for joining parts
- Used code in LS-Dyna for modeling steel.

The mentioned FE model has been prepared and developed by NCAC[14]. Also a real full-scaled test has been done on the C1500 Pick-up Truck. According to **Error! Reference source not found.** the simulation results obtained from the developed FE model correlates well with the measured data. The simulation confirms that the accuracy of the FE model is independent of the general geometry. This strategy is a common way for those crash analysis which lack experimental results[1]. The final prepared FE model of IranKhodro 2624 is reliable can be used for other crash simulations.

9. Conclusions

An FE model was developed to simulate ECE-R29 regulation for IranKhodro 2624. The 3D cad model of different parts of the truck was made and assembled together to construct the whole structure of the truck cabin.

The verification of FE model was carried out by an indirect method. A similar FE model was prepared for C1500 Pick-up Truck, and it underwent similar Tests. The obtained results were compared with experimental data available in literature. The good agreement between the measured and computed results indicates that the developed model of Iran Khodro 2624 is somehow accurately made.

Three different tests were then simulated. Although the cabin passed all the tests, there was not sufficient safety margin in Test-B. Thus, in this study, two approaches are suggested to enhance the dynamic response of the cabin.

The first approach was based on replacing the roof shell with a thicker one. It was shown that by

increasing 0.5mm in shell thickness, the safety margin is increased by 4.5 cm.

The effect of rims was also studied and they can diminish the roof buckling. The proposed rims in the paper reduced the maximum buckling of the roof by 5cm.

References

- [1]. 1. Leslaw Kwasniewski et, a., Crash and safety assessment program for paratransit buses. *International Journal of Impact Engineering*, 2009. 36.
- [2]. 2. Deshmukh, P., Rollover And Roof Crush Analysis Of Low-Floor Mass Transit Bus. 2006, Wichita State University.
- [3]. 3. Ganesh, School Bus Crashworthiness, in *Mechanical Engineering*. 1998, Virginia University.
- [4]. 4. Raich, H., Safety Analysis of the New Actros Megaspaces Cabin According to ECE-R29/02, in *4th European LS-DYNA Users Conference: Germany*.
- [5]. 5. Yadav, V., Finite Element Modeling And Side Impact Study Of A Low-Floor Mass Transit Bus, in *Mechanical Eng*. 2003, Wichita State University.
- [6]. 6. "ECE R-29", Regulation No. 29; uniform provisions concerning the approval of vehicles with regard to the protection of the occupants of the cab of a commercial vehicle; Revision 1, 1998.
- [7]. 7. Cheng, Experiences In Reverse-Engineering Of A "Nite Element Automobile Crash Model. *Finite Elements in Analysis and Design* 2001. 37.
- [8]. 8. LS-DYNA, Keyword User's Manual Volume 1, Version 960 Livermore Software Technology Corporation. March 2001.
- [9]. 9. Thacker, Experiences During Development Of A Dynamic Crash Response Automobile Model. *Finite Elements in Analysis and Design*, 1998. 30.
- [10]. 10. NIMBALKAR, R., Finite Element Modeling Of A Transit Bus. 2003, Florida State University.
- [11]. 11. Bois, P.D., Vehicle Crashworthiness And Occupant Protection. 2004: American Iron and Steel Institute.
- [12]. 12. Dsouza2010, R., Development and validation of a computer crash simulation model of an occupied adult manual wheelchair

subjected to a frontal impact. Medical Engineering & Physics, 2010. 32(3).

- [13]. 13.Nijagal, K., Design And Evaluation Of Composite Car-Front Subframe Rails In A Sedan And Its Corresponding Occupant Crash Injury Response. 2001, Wichita State University
- [14]. 14.<http://www.ncac.gwu.edu/>.